

GENUINE



# YZ 125 G

**OWNER'S/SERVICE MANUAL**

## IMPORTANT

THIS MACHINE IS DESIGNED STRICTLY FOR COMPETITION USE ONLY. IT IS ILLEGAL TO OPERATE THIS VEHICLE ON STREET, OFF ROAD USE ON PUBLIC LAND MAY BE ILLEGAL. PLEASE CHECK YOUR LOCAL RIDING AREA REGULATIONS.

### SAFETY WARNINGS:

- 1. GASOLINE IS HIGHLY FLAMMABLE:**
  - \* Always turn off the engine when refueling.
  - \* Take care not to spill on the engine or exhaust pipe/muffler, when refueling.
  - \* If any gasoline spills on the engine or exhaust pipe/muffler, wipe it off immediately.
  - \* Never refuel while smoking or in the vicinity of an open flame.
- 2. If you should swallow some gasoline, inhale a lot of gasoline vapor, or allow some gasoline to get in your eye(s), see your doctor immediately. If any gasoline spills on your skin or clothing, immediately wash it with soap and water, and change your clothes.**
- 3. Do not touch any moving or heated areas.**
  - \* The engine and exhaust pipe/muffler are heated the during operation. Park the machine in a place where pedestrians or children are not likely to touch the machine.
  - \* Do not park the machine on a slope or soft ground, the machine can easily overturn.
- 4. When transporting the machine in another vehicle, be sure it is kept upright and that the fuel petcock is turned to the "OFF" position. If it should lean over, gasoline may leak out of the carburetor or fuel tank.**
- 5. Never start your engine or let it run for any length of time in a closed area. The exhaust fumes are poisonous and can cause loss of consciousness and death within a short time. Always operate your machine in an area with adequate ventilation.**
- 6. Always wear a helmet, gloves, boots, trousers, and jacket for motocross riding.**

### YZ125G OWNER'S SERVICE MANUAL

1st Edition - September 1979  
2nd Printing - March 1980 JEM

ALL RIGHTS RESERVED BY  
YAMAHA MOTOR CORPORATION, U.S.A.  
BUENA PARK, CALIFORNIA 90620

LIT-11625-02-05

## INTRODUCTION

Congratulations on your purchase of the Yamaha YZ125G. This model represents the product of many years of Yamaha experience in the production of fine sporting, touring, and pace setting racing machines. You can now appreciate the high degree of craftsmanship and reliability that have made Yamaha a leader in these fields.

This manual will provide you with a good basic understanding of features, operation, basic maintenance, and inspection of this vehicle.

**PLEASE READ THIS MANUAL CAREFULLY AND COMPLETELY BEFORE OPERATING YOUR NEW MACHINE.** If you have any questions regarding the operation or maintenance of your machine, please consult your Yamaha dealer.

Particularly important information is distinguished in this manual by the following notations:

**NOTE:** . . . . . A NOTE provides key information to make procedures easier or clearer.

**CAUTION:** . . . A CAUTION indicates special procedures that must be followed to avoid damage to the machine.

**WARNING:** . . . A WARNING indicates special procedures that must be followed to avoid injury to a machine operator or person inspecting or repairing the machine.

## NOTICE

Some data in this manual may become outdated due to improvements made to this model in the future. If there is any question you have regarding this manual or your machine, please consult your Yamaha dealer.

SERVICE DEPT.  
INTERNATIONAL DIVISION  
YAMAHA MOTOR COMPANY, LTD.

# CONTENTS

<b>GENERAL INFORMATION</b> .....	1
MACHINE IDENTIFICATION .....	1
CONTROL FUNCTION .....	1
FUEL AND OIL .....	2
PRE-OPERATION CHECKS .....	3
STARTING AND OPERATION .....	3
<b>PERIODIC MAINTENANCE AND ADJUSTMENTS</b> .....	5
MAINTENANCE AND LUBRICATION SCHEDULE CHART .....	5
LUBRICATION .....	7
SPECIAL TOOLS .....	9
ADJUSTMENTS .....	10
<b>MAINTENANCE AND MINOR REPAIRS</b> .....	17
PREPARATION FOR SERVICE .....	17
ENGINE .....	17
CHASSIS .....	35
SUSPENSION TUNING .....	41
ELECTRICAL .....	46
<b>MISCELLANEOUS</b> .....	48
WIRING DIAGRAM .....	48
CABLE ROUTING DIAGRAM .....	49
TROUBLE SHOOTING GUIDE .....	51
CLEANING AND STORAGE .....	55
SPECIFICATIONS .....	56
WARRANTY INFORMATION .....	62

# GENERAL INFORMATION

## MACHINE IDENTIFICATION

### Frame serial number

The frame serial number is stamped on the right side of the steering head pipe.

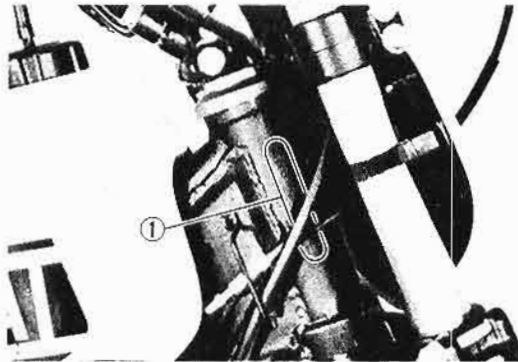

1. Frame serial number

### Engine serial number

The engine serial number is stamped into the elevated part of the right rear section of the engine.

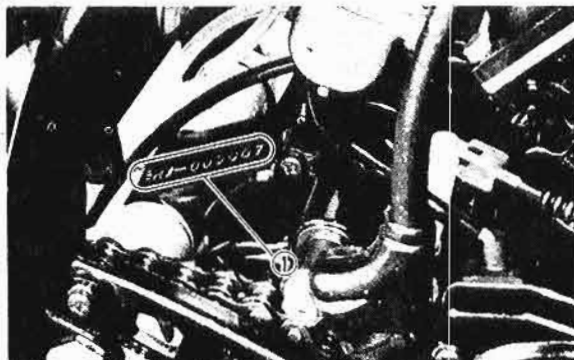

1. Engine serial number

### NOTE:

The first three digits of these numbers are for model identifications; the remaining digits are the unit production number.

Keep a record of these numbers for reference when ordering parts from your Yamaha dealer. In case of theft, the authorities will need these numbers and your model name for identification.

## CONTROL FUNCTIONS

### WARNING:

Before riding this machine, become thoroughly familiar with all operating controls and their function.

Consult your Yamaha dealer regarding any control or function you do not thoroughly understand.

### NOTICE:

This motorcycle is designed strictly for competition use only. It is not equipped with highway approved lighting. Off-road use on public land may be illegal.

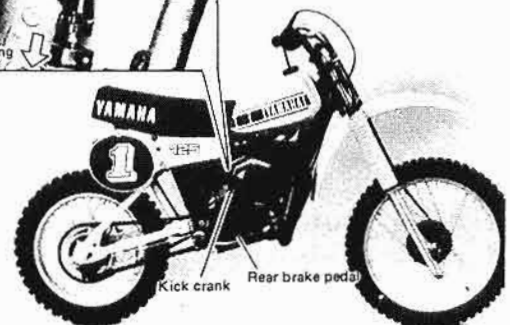
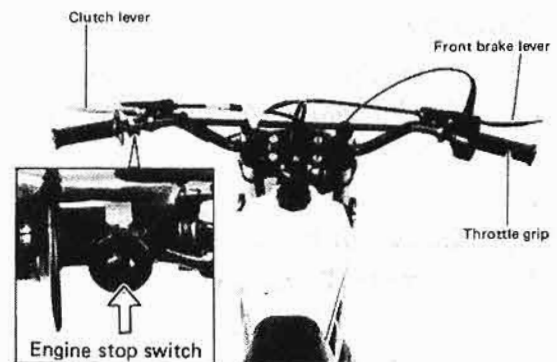

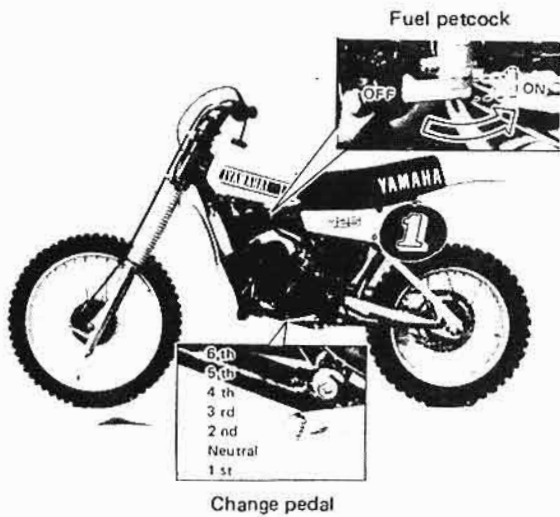

Change pedal

### Starter knob

When cold, the engine requires richer fuel mixture for starting. Pull the knob up to open the circuit (for starting) and push it down to close the circuit before riding. Never ride the machine with the starter knob up.

## FUEL AND OIL

### Fuel

Use premium gasoline with an octane rating of 90+ mixed with oil at a gas/oil ratio of specification. Always use fresh, name-brand gasoline. Always mix a fresh batch of fuel the morning of the race and do not retain a mixed batch overnight.

Fuel tank capacity: 6.5 lit (1.7 US. gal)

### Engine mixing oil

Recommended oil: Yamalube "R"  
(Yamalube Racing 2-cycle oil)  
Mixing ratio : 32 : 1

If for any reason you should use another type, select from the following list.

\*Shell Super M  
\*Castrol R30  
Mixing ratio: 20 : 1

### CAUTION:

Always use the oil of same brand.  
Never use any other brand of oil.

### Transmission oil

Recommended oil:  
Yamalube 4-cycle oil or SAE  
10W/30 "SE" motor oil

### OIL REPLACEMENT

Replace the transmission oil after the first use and thereafter, replace it every five races. On the bottom of the engine there is a drain plug. Remove it and drain all the oil from the transmission. Reinstall the drain plug (make sure it is tight). Add oil through filler hole.

Transmission oil capacity:  
Periodic oil change:  
600 cc (0.63 US qt)  
Overhaul:  
700 cc (0.74 US qt)

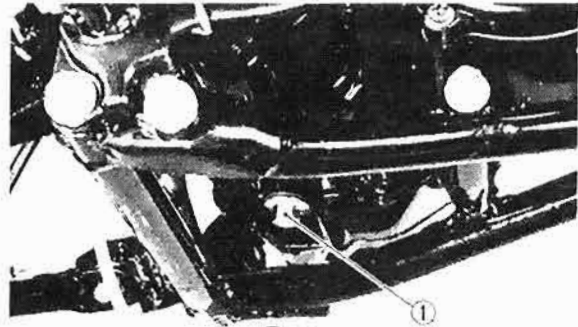

1. Drain plug

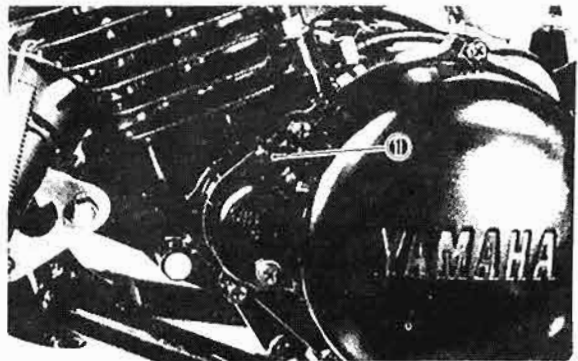

1. Filler plug



## CHECKING OIL LEVEL

On the left side of the engine there is a checking screw. To check, warm up the engine for 2 ~ 3 minutes. Stop engine. Place the machine upright and remove the oil level checking screw. If oil flows out, the oil level is correct. If the oil level is lower than specification, add oil.



1. Checking screw

## PRE-OPERATION CHECKS

Before using this machine please check the following points:

Item	Procedure	Page
Brakes	Check operation/adjustment	14
Clutch	Check operation/adjustment	13, 14
Fuel tank	Fill with proper fuel/oil mixture	2
Transmission oil	Check oil level/Change oil as required	2, 3
Drive chain	Check alignment/adjustment/lubrication	14, 15
Spark plug	Check color and condition/Replace as required	10
Throttle cable	Check for proper cable operation	11
Air filter	Clean and damp with oil	12, 13
Wheels & tires	Check pressure/runout/spoke tightness/axle nuts	43, 44
Fittings/fasteners	Check all/tighten as necessary	—

### NOTE:

Pre-operation checks should be made each time the machine is used. Such an inspection can be thoroughly accomplished in a very short time and the added safety it assures is more than worth the time involved.

## STARTING AND OPERATION

### CAUTION:

Before operating the machine, perform steps listed in pre-operation check list.

### WARNING:

Never start your engine or let it run for any length of time in a closed area. The exhaust fumes are poisonous and can cause loss of consciousness and death within a short time. Always operate your machine in an area with adequate ventilation.

### Starting a cold engine

Shift transmission into "NEUTRAL". Turn the fuel petcock to "ON", operate the starter knob and completely close the throttle grip. Engage the kick starter and start the engine.

### Warm-up

Run the engine at idle or slightly higher using the starter knob as required until the engine is warm. This procedure normally takes 1 to 2 minutes. To check, see if the engine responds normally to throttle with starter knob off.

**CAUTION:**

**Do not operate engine for extended warm-up periods.**

**Starting a warm engine**

Do not engage starter knob. Open throttle slightly. Engage the kick starter and start the engine.

**CAUTION:**

**Observe break-in procedures for initial operation.**

**Break-in procedures**

1. Prior to starting, fill tank with a break-in gasoline/oil mixture of 12:1 ~ 14:1.
2. After fueling and pre-operational checks have been made, refer to "Starting and Operation" and start engine.
3. Allow engine to warm up. Check engine idle speed. Check operating controls and "Engine stop switch operation".
4. Operate machine in lower gears at moderate throttle settings for 5 ~ 8 minutes. Check spark plug condition. Spark plug will show rich condition during break-in.
5. Allow engine to cool. Repeat procedure, running for 5 minutes. Very briefly, shift to higher gears (4th or 5th) and check full throttle response. Check spark plug condition.
6. Allow engine to cool. Repeat procedure, running for 5 minutes. Full throttle and higher gears may be used, but avoid sustained full throttle operation. Check spark plug condition.
7. Allow engine to cool. Remove cylinder head and inspect.  
For disassembly, refer to page 22. Remove "high" spots on piston with No.600 grit, wet sandpaper. Clean and carefully reassemble.
8. Remove break-in fuel/oil mixture from tank. Refill with specified operation fuel/oil mixture. Check entire unit for loose or mis-adjusted fittings/controls /fasteners.

9. Re-start engine and check through entire-operating range thoroughly. Stop. Check spark plug condition. Restart. After 10~ 15 minutes operation, machine is ready to race.

**CAUTION:**

**After the break-in period, check every fitting and fastener for looseness. If any loose is found, retighten it securely.**



# PERIODIC MAINTENANCE AND ADJUSTMENTS

## MAINTENANCE AND LUBRICATION SCHEDULE CHART

The maintenance and lubrication schedule chart should be considered strictly as a guide to general maintenance and lubrication intervals. You must take into consideration that weather, terrain, geographical locations, and a variety of individual uses all tend to demand that each owner alter this time schedule to match his environment. For example, if the machine is continually operated in an area of high humidity, all parts must be lubricated much more frequently than shown on the chart to avoid rust and damage. If you are in doubt as to how closely you can follow these time recommendations, check with the Yamaha dealer in your area.

Item	Every race	Every two races	Every three races	Every five races	As required	Recommend lubricant
PISTON Clean/Inspect for cracks and seizure	○					
Replace				○		
PISTON RING Replace		○				
CYLINDER HEAD Inspect distortion/cracks	○					
Clean/Retighten	○					
CYLINDER Clean/Inspect for seizure	○					
Replace					○	
Retighten	○					
CLUTCH Adjust			○			
Inspect for wear/damage	○					
Replace					○	
TRANSMISSION Change oil				○		Yamalube 4-cycle oil or SAE 10W/30 "SE" motor oil
Inspect gears and shift fork for wear/bending				(○)	○	
Replace bearing					○	
ENGINE MAIN BEARING Inspect wear				○		
CONNECTING ROD Inspect bearings for wear				○		
Replace					○	
PISTON PIN Inspect wear/heat damage				○		
Replace					○	
CDI ROTOR UNIT Retighten				○		
KICK STARTER Inspect idle gear for damage/wear					○	
Replace					○	

Item	Every race	Every two races	Every three races	Every five races	As required	Recommend lubricant
EXHAUST SYSTEM Inspect for cracks	<input type="radio"/>					
Cleaning				<input type="radio"/>		
CARBURETOR Inspect/Adjust	<input type="radio"/>					
Clean/Retighten	<input type="radio"/>					
AIR FILTER Clean and lube	<input type="radio"/>					Air filter must be cleaned and damp with oil after every race. Do not over-oil. Use SAE 10W/30 motor oil.
Replace					<input type="radio"/>	
SPARK PLUG Inspect for condition	<input type="radio"/>					
Replace					<input type="radio"/>	
DRIVE CHAIN Clean and lube	<input type="radio"/>					a. Yamaha chain and cable lube b. SAE 10W/30 motor oil
Check tension and alignment	<input type="radio"/>					
Replace					<input type="radio"/>	
FRAME Clean/Inspector for cracks	<input type="radio"/>					
FUEL TANK PETCOCK Clean					<input type="radio"/>	
FRONT FORK Change oil				Initial 5	After 10 race	Yamaha fork oil 10 wt
Replace seal					<input type="radio"/>	
Check and adjust air pressure	<input type="radio"/>					
REAR SHOCK ABSORBER Inspect/Adjust	<input type="radio"/>					
Lube	<input type="radio"/>					
STEERING HEAD Inspect	<input type="radio"/>					Medium-weight wheel bearing grease of quality manufacture (preferable waterproof)
Clean/Lube				<input type="radio"/>		
Replace bearings					<input type="radio"/>	
SWING ARM Inspect for cracks	<input type="radio"/>					Medium-weight wheel bearing grease of quality manufacture (preferable waterproof)
Lube	<input type="radio"/>					
CHAIN GUARD Replace					<input type="radio"/>	Chain roller, guard and tensioner





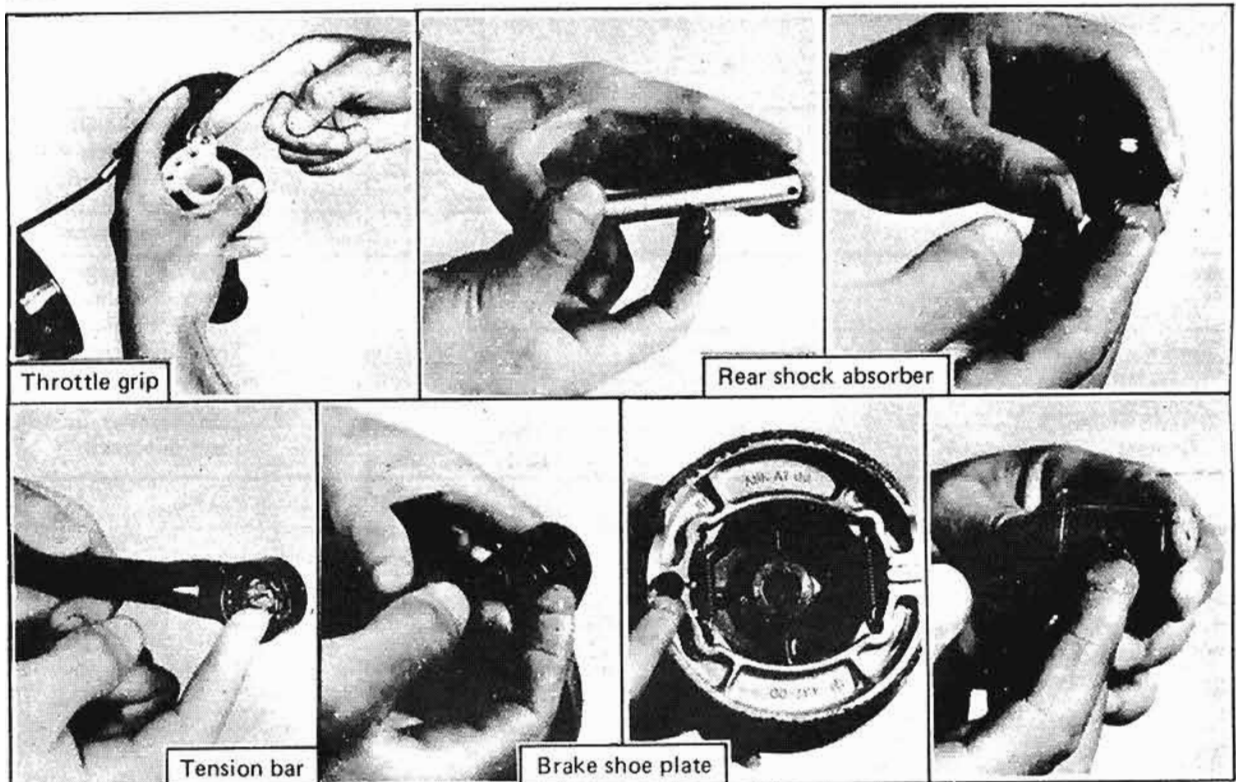





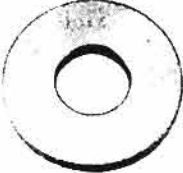

Item	Every race	Every two races	Every three races	Every five races	As required	Recommend lubricant
<b>WHEELS AND TIRES</b> Check pressure/runout/ spoke tension	○					Medium-weight wheel bearing grease of quality manufacture (preferable waterproof)
Inspect bearings for wear	○					
Lube oil seal			○			
Replace bearings					○	
<b>THROTTLE</b> Lube	○					
<b>CONTROL CABLES</b> Routing (Connection)	○					SAE 10W/30 motor oil
Inspect/Lube	○					
<b>CLUTCH AND BRAKE LEVER PIVOT</b> Lube/Retighten	○					SAE 10W/30 motor oil
<b>KICK CRANK, BRAKE PEDAL AND FOOTREST PIVOT</b> Lube	○					Lithium base grease
Retighten	○					
<b>BOLTS AND NUTS</b> Retighten	○					
<b>BRAKE</b> Clean/Inspect/Adjust Lube	○					Lithium base grease
Replace					○	

## LUBRICATION



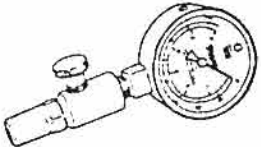
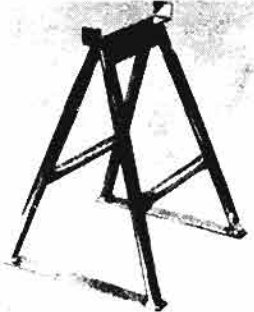

# SPECIAL TOOLS

<p>1</p> 	<p>2</p> 	<p>3</p> 
<p>90109-20405 Rotor puller</p>	<p>90890-01022 Clutch holding tool</p>	<p>90890-01135 Crankcase separating tool</p>
<p>4</p> 	<p>5</p> 	<p>6</p> 
<p>90890-01012 Crankshaft setting pot</p>	<p>90890-01016 Spacer</p>	<p>90890-01015 Crankshaft setting tool</p>
<p>7</p> 	<p>8</p> 	<p>9</p> 
<p>90890-01051 Steering nut wrench</p>	<p>90890-01212 Cylinder fork guide wrench</p>	<p>90890-03002 Dial gauge</p>
<p>10</p> 	<p>11</p> 	<p>12</p> 
<p>90890-01195 Dial gauge stand</p>	<p>90890-03098 Dial gauge stem</p>	<p>90890-03104 Pocket tester</p>
<p>13</p>  <p>90890-03085 Air check gauge</p>	<p><b>Machine stand</b> The machine stand shown below will greatly facilitate your service.</p> 	

# ADJUSTMENTS

## Spark plug

Standard spark plug:  
N-59G (CHAMPION)

1. Measure the electrode gap with a wire thickness gauge.

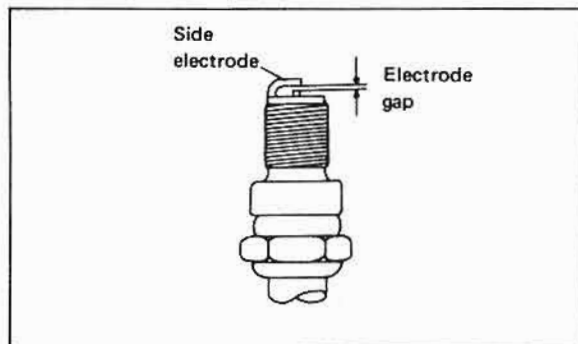

Adjustment can be made by bending the side electrode.

Electrode: 0.7 mm (0.028 in)

When installing the plug, always clean the gasket surface and use a new gasket. Wipe off any grime from the threads and torque the spark plug properly.

Spark plug torque: 2.5 m·kg (18 ft·lb)

2. The insulator must be medium-to-light tan color. If not, check carburetion, ignition timing, and gas-oil mixing ratio. If the porcelain is a very dark brown or black color, then a plug with a hotter heat range may be required. This situation is quite common during the engine break-in period. However, use the standard plug. If the insulator tip shows a very light tan or white color or is actually pure white or if the electrodes show signs of melting, then a spark plug with a colder heat range is required.

### NOTE:

If a torque wrench is not available when you are installing a spark plug, a good estimate of the correct torque is 1/2 to 1/4 turns past finger tight. Have the spark plug torqued to

the correct value as soon as possible with a torque wrench.

## Ignition timing

Ignition timing must be set with a dial gauge (to determine piston position).

Proceed as follows:

1. Remove spark plug. Screw Dial Gauge Stand into spark plug hole.
2. Insert Dial Gauge Assembly with a 56 mm (2.2 in) extension (stem) into stand.



3. Remove right engine crankcase cover.
4. Rotate rotor until piston is at top-dead center (T.D.C.). Tighten set screw on dial gauge stand to secure dial gauge assembly. Set the zero on dial gauge face to line up exactly with dial gauge needle. Rotate rotor back and forth to be sure that gauge needle does not go past zero.

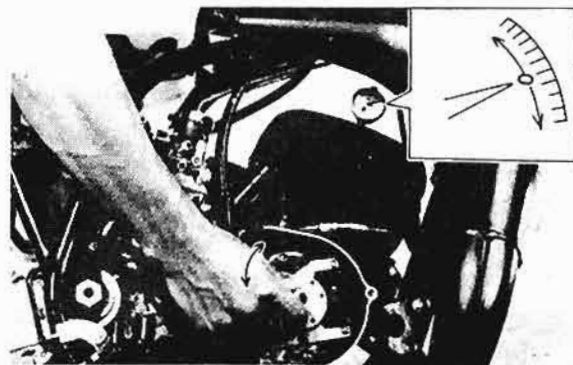

5. Starting at T.D.C., rotate rotor counter-clockwise until dial indicator reads 0.68 mm (0.027 in) before top-dead center (B.T.D.C.).

Ignition timing: 2.27 mm (0.089 in)



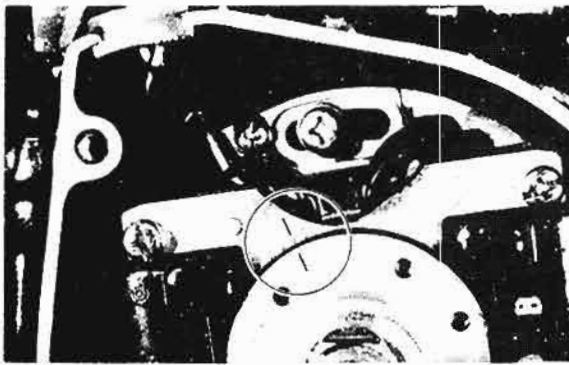

6. Check to see that the rotor timing mark aligns with the starter timing mark. To adjust, loosen the two starter retaining screws and rotate the starter. Tighten screws and recheck the ignition timing.

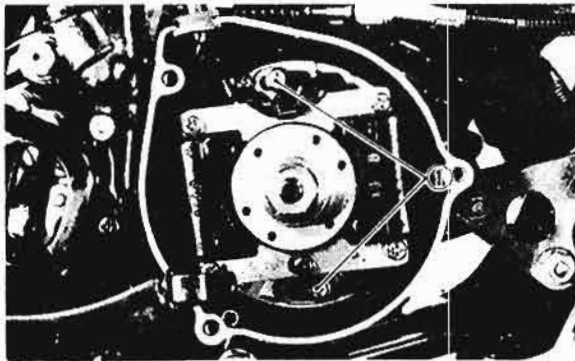

1. Retaining screw

7. Remove dial gauge assembly and stand. Replace spark plug.

Spark plug torque: 2.5 m·kg (18 ft·lb)

8. Replace engine crankcase cover.

#### Rotor removal

When removing the rotor, use the rotor puller.

1. Shift into second gear and press down on the brake pedal.
2. Remove the rotor holding nut.
3. Install the rotor puller and tighten it.

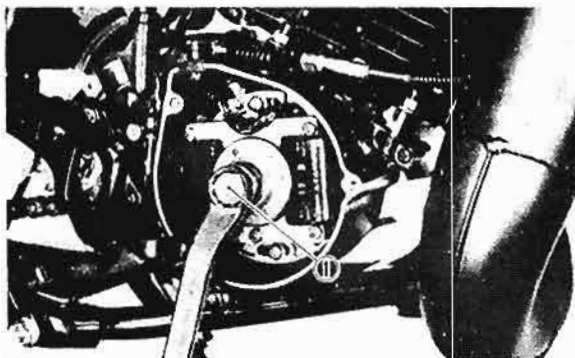

1. Rotor puller

Tightening torque: 3.5 m·kg (26 ft·lb)

#### Throttle cable adjustment

Check play in turning direction of throttle grip. The play should be 3~5 mm (0.12~0.20 in) at grip flange. Loosen the lock nut and turn the wire adjuster to make the necessary adjustment. Be sure to tighten the lock nut properly.

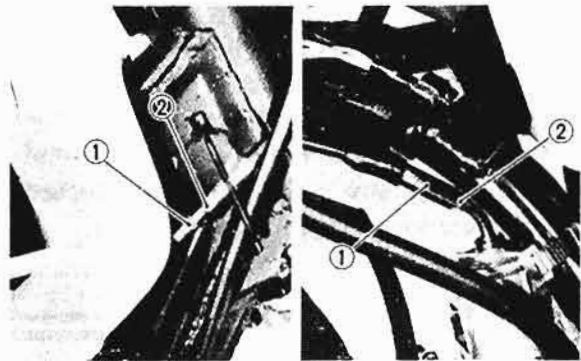
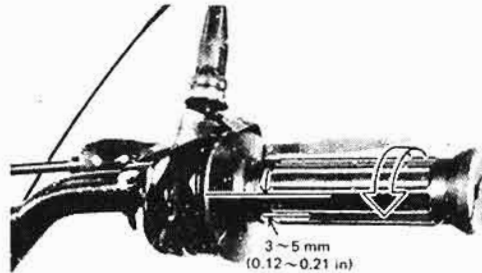

1. Adjuster 2. Lock nut

After adjustment, start the engine and check that the throttle grip turns smoothly. Also check if the engine speed increases suddenly when the handlebars are turned to limits in either direction.

#### Idle speed adjustment

1. Turn the pilot air screw in until lightly seated.
2. Back out by the specified number of turns. Start the engine and let it warm up.

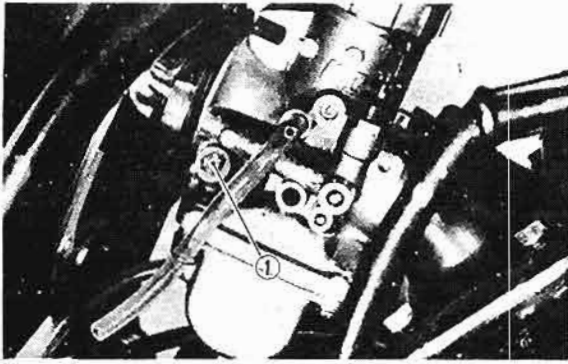

1. Pilot air screw

Pilot air screw turns out:  $1\frac{1}{2}$

3. Turn the throttle stop screw until idle is at desired rpm.

**NOTE:** \_\_\_\_\_

A lock nut is incorporated for positive retention of throttle stop screw.

4. Turn the pilot air screw in or out until idle speed is at highest rpm.
5. Turn the throttle stop screw in or out until idle speed is at desired rpm.

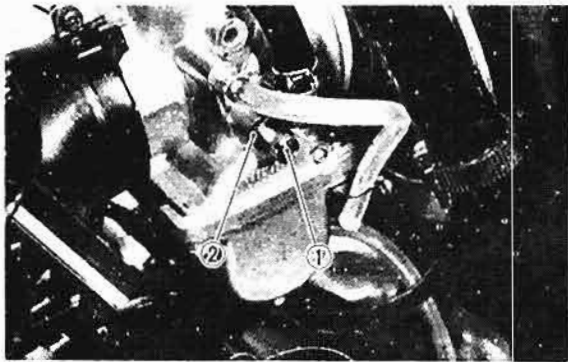

1. Throttle stop screw 2. Lock nut

**NOTE:** \_\_\_\_\_

Pilot air and throttle stop screws should be so adjusted that engine response from idle position is rapid and without hesitation.

If the engine, when warm, hesitates after adjusting as described, turn the idle air mixture screw in or out in  $1/4$  turn increments until the problem is eliminated.

**AIR FILTER**

The air filter protects the engine from dirt which can enter with the intake air and cause rapid engine wear.

This model's double layer filter should be cleaned at every race.

**Removal**

1. Remove the wing nut and remove the filter case cover.



2. To take the filter out of the case, remove first the stay from the filter case and then the plate from the filter.

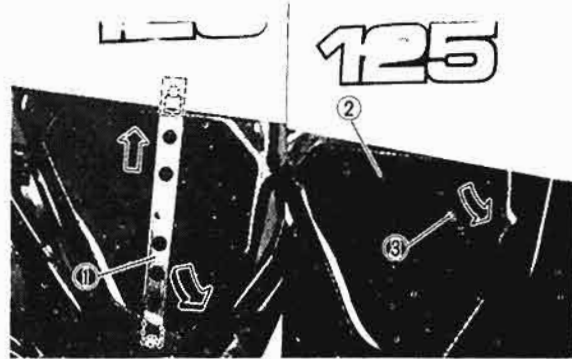

1. Stay 2. Filter 3. Plate



**Cleaning**

1. Wash the filter gently, but thoroughly, in solvent.
2. Squeeze the excess solvent out of the filter and let it dry.
3. Pour a small quantity of 30W motor oil onto the filter and work thoroughly into the porous foam material.
4. Re-insert the guide into the filter.

**NOTE:**

In order to function properly, the filter must be damp with oil at all times but not "dripping" with oil.

5. Coat the sealing edges of the filter with light grease. This will provide an air-tight seal between the filter case cover and filter seat.

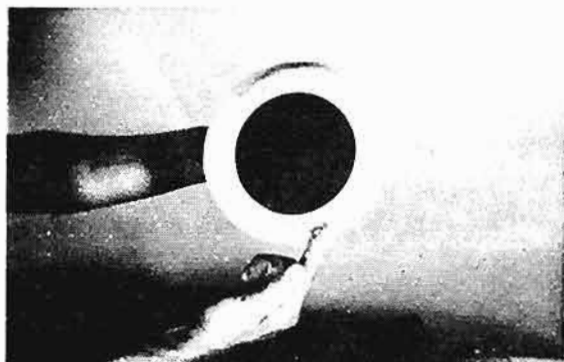

6. Reinstall the filter assembly and parts removed for access.

**NOTE:**

Each time air filter maintenance is performed, check the air inlet to the filter case for obstructions. Check the air filter joint rubber to the carburetor and manifold fittings for an air-tight seal. Tighten all fittings thoroughly to avoid the possibility of unfiltered air entering the engine.

**CAUTION:**

Never operate the engine with the air filter removed. This will allow unfiltered air to enter causing rapid wear and possible engine damage. Additionally, operation without the air filter will affect carburetor jetting with subsequent poor performance and possible engine overheating.

## CLUTCH

### Mechanism adjustment

1. Fully loosen the cable in-line length adjuster lock nut and screw in the adjusters until tight.
2. Turn the handle lever adjuster in.
3. Footrest holds with two bolts, remove rear one and loosen the front one. Remove the change pedal.
4. Drain the transmission oil and remove the crankcase cover.

5. Loosen the adjuster lock nut on the pressure plate.

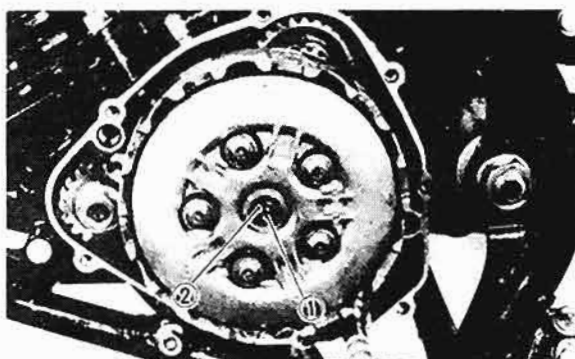

1. Adjuster 2. Lock nut

6. By turning the cable in-line length adjuster, bring the point of push lever to align with the match mark on the case, and tighten the lock nut.

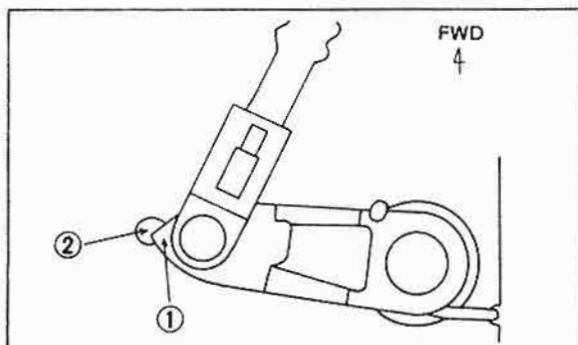

7. Turn the mechanism adjuster in until resistance is felt, then back out 1/4 turns, and tighten the lock nut.

Tightening torque: 0.8 m·kg (6 ft·lb)

8. Adjust the lever freeplay.

### Lever adjustment

Clutch should be adjusted to suit rider preference with a minimum cable slack of 2 ~ 3 mm (0.08 ~ 0.12 in) play at the clutch lever pivot side.

1. Loosen the lever adjuster lock nut and turn the lever adjuster either in or out until proper lever free play is achieved. Tighten the lock nut.

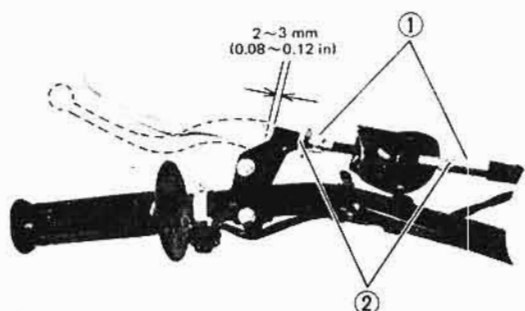

1. Adjuster 2. Lock nut

### Front brake

Front brake should be adjusted to suit rider preference with a minimum cable slack of 5 ~ 8 mm (0.2 ~ 0.32 in) play at the brake lever pivot side.

1. Loosen the adjuster lock nut.
2. Turn the cable length adjuster in or out until adjustment is suitable.
3. Tighten the adjuster lock nut.

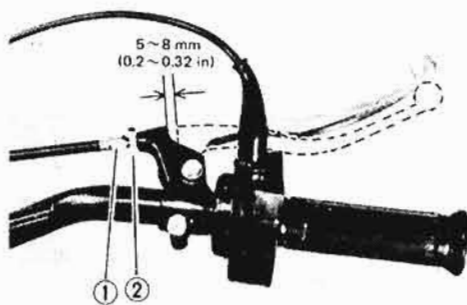

1. Adjuster 2. Lock nut

4. When adjusting the cable length on the brake hub side, first screw in the adjuster on the brake lever side and adjust to specification.

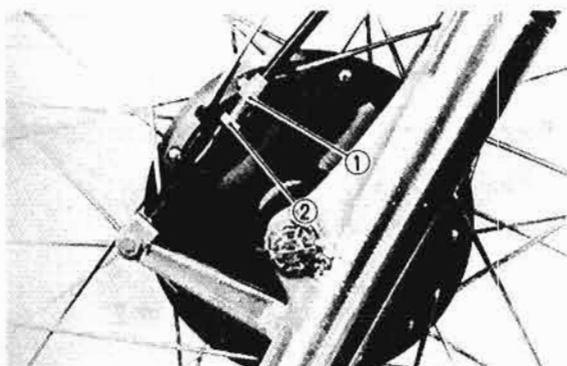

1. Adjuster 2. Lock nut

### Brake pedal position adjustment

The position of the rear brake pedal should be adjusted to suit the rider.

1. Loosen adjuster on the brake rod.
2. Loosen the lock nut and adjust the pedal height by turning the adjuster.
3. After adjusting, check for correct rear brake play. Do not forget to tighten the lock nut.

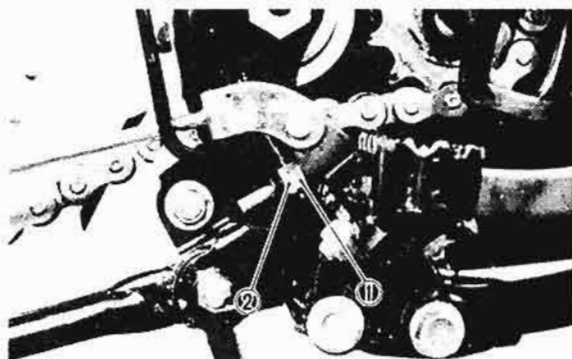

1. Adjuster 2. Lock nut

### Rear brake

Adjust rear brake pedal play to suit the rider preference, providing a minimum of 20~30 mm (0.8~1.2 in) freeplay. Turn the adjuster on the rear brake ferrule in or out until brake pedal freeplay is suitable.

### NOTE:

Rear brake pedal adjustment must be checked whenever chain is adjusted or rear wheel is removed and then re-installed.

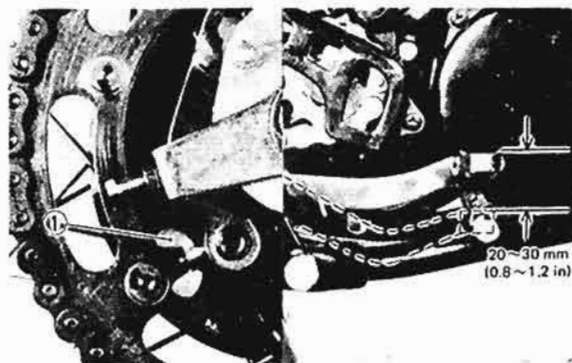

1. Adjuster

### Drive chain tension check

To check the chain play, the machine must stand vertically with its both wheels on the ground and without operator on it.

Check the tension at the position shown in

the photo. The normal vertical deflection is approximately 10~15 mm (0.39~0.59 in). If the deflection exceeds 15 mm (0.59 in) adjust the chain tension.

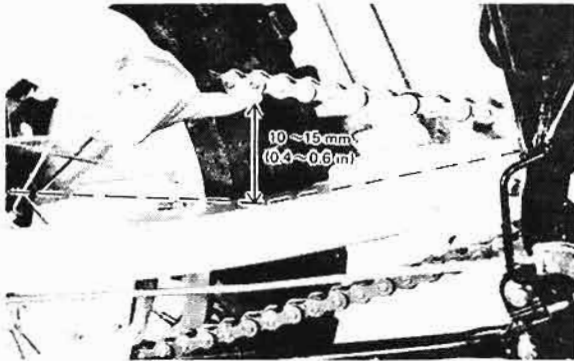

### Adjustment

1. Loosen axle securing nut and adjuster lock nut.
2. Turn adjusting bolts left and right until the adjust marks on the chain pullers are aligned with the adjust marks on each side of the swing arm. Tighten lock nuts on adjusting bolts.

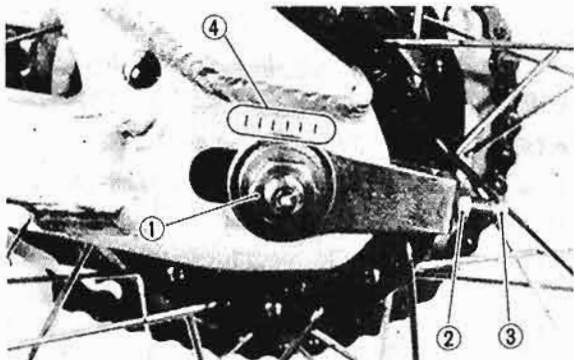

1. Axle securing nut      3. Adjusting bolt  
2. Lock nut              4. Adjust mark

### NOTE:

Be sure that both right and left adjusting bolts are in the corresponding positions.

3. Tighten the rear axle securing nut.

Torque: 8.5 m·kg (60 ft·lb)

4. Check brake pedal freeplay.

### CAUTION:

Whenever the chain is adjusted and/or the rear wheel is removed, always check during reassembly:

1. Rear axle alignment.
2. Brake pedal free play.

### Steering head adjustment

1. With front wheel elevated, grab bottoms of fork legs and gently push and pull to check steering head free play. There should be no noticeable free play.

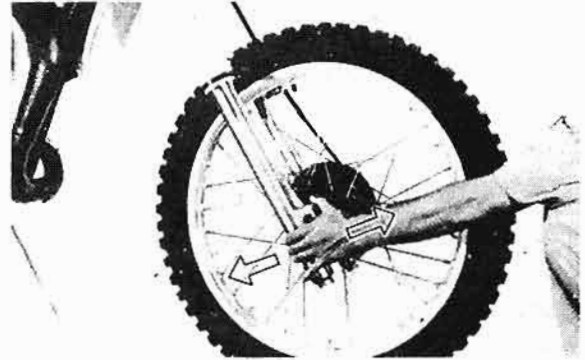

### NOTE:

Forks must swing from lock to lock without binding or catching. If it is felt, check the bearing or loosening.

2. To adjust, first loosen upper stem pinch bolt.
3. Loosen steering fitting bolt.

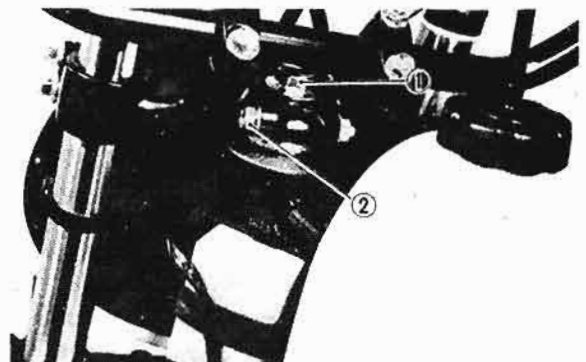

1. Steering fitting bolt      2. Stem pinch bolt

4. Use steering nut wrench to tighten ring nut. Tighten until free play is eliminated.

Tightening torque: 1.0 m·kg (7 ft·lb)

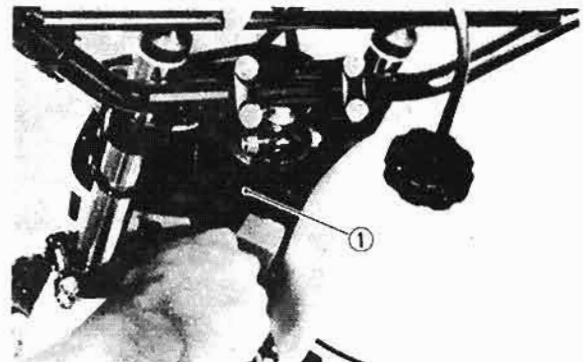

1. Steering nut wrench



5. Tighten fitting bolt and torque to specification.

Fitting bolt torque: 9.5 m-kg (68 ft-lb)

6. Tighten pinch bolt at fork crown and torque to specification.

Stem pinch bolt torque:  
2.3 m-kg (17 ft-lb)



# MAINTENANCE AND MINOR REPAIRS

## PREPARATION FOR SERVICE

- \* Before servicing the machine, be sure to clean machine exteriors.
- \* Place the removed parts on a tray in the order of removal.
- \* When replacing parts, always use genuine Yamaha parts to maintain better performance, durability and safety.
- \* All gaskets and seals should be replaced when the engine is overhauled. All gasket surfaces must be cleaned.
- \* Properly oil all mating engine and transmission parts during assembly.
- \* All circlips should be inspected before assembly. Replace distorted circlips.
- \* Always replace cotter pins when reassembling.
- \* When installing parts, apply grease or oil to them, as required, and follow the torque chart. (Refer to "Maintenance & Lubrication Schedule Chart.")
- \* For assembly, reverse the procedure for removal.

## ENGINE

### CARBURETOR

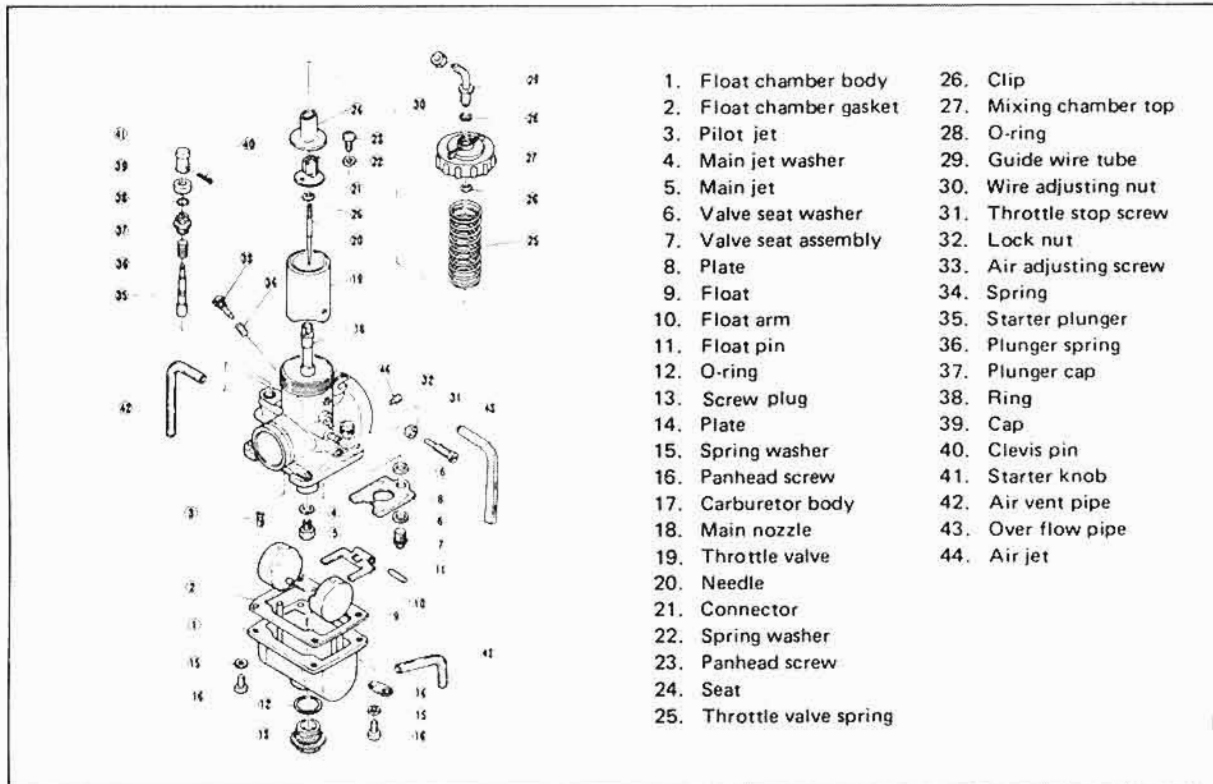

#### Replacement of main jet

1. Turn fuel petcock lever to the "OFF" position.
2. Disconnect the fuel hose.
3. Loosen the manifold and inlet joint bands (hose clamps).
4. Rotate carburetor, exposing main jet cover bolt.

Remove bolt. Main jet is located directly behind bolt.

5. Remove the main jet. Change as required. Reinstall cover bolt and reassemble, reversing steps 1 through 3.

Standard Main Jet Size: # 300

**WARNING:**

Removing the main jet cover bolt to allow the fuel in the float bowl to drain. Do not remove if engine is hot. Place a rag under carburetor to catch overflow. Remove bolt in well-ventilated area. Do not remove near open flame. Always clean and dry machine after reassembly.

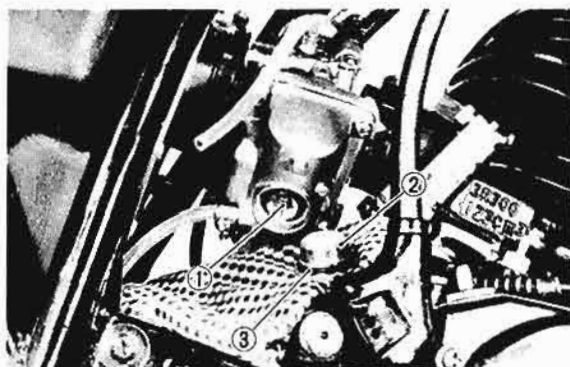

1. Main jet 2. Cover bolt 3. O-ring

**IMPORTANT:**

The carburetor has been set for normal sea level conditions. The standard setting is the result of extensive testing and does not usually require changing. However, under conditions of high atmospheric pressure or heavy load (deep sand or mud) the standard main jet should be replaced with another main jet. If the carburetor requires any other setting changes to suit local conditions of altitude, weather, etc., the changes must be made with great care. Improper carburetor setting changes will cause poor engine performance and/or possible engine damage. Please consult your YAMAHA dealer about any carburetor setting changes before actually going about them.

**Inspection**

1. Examine carburetor body and fuel passages. If contaminated, wash carburetor in petroleum based solvent. Do not use caustic carburetor cleaning solutions. Blow out all passages and jet with compressed air.
2. Examine condition of floats. If floats are damaged, they should be replaced.

3. Inspect inlet needle valve and seat for wear or contamination. Replace these components as a set.

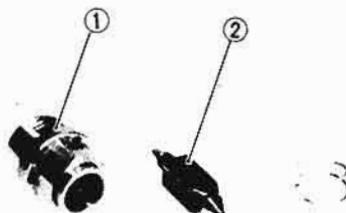

1. Valve seat 2. Needle valve

**Adjustment**

1. Float height
  - a. Checking

Hold the carburetor in an upside down position.

Incline the carburetor at  $60^{\circ} \sim 70^{\circ}$  (so that the end of the float valve does not hang down of float weight), and measure the distance from the mating surface of the float chamber (gasket removed) to the top of the float arm using a gauge.

**Float height:**

$23.4 \pm 1.0$  mm ( $0.92 \pm 0.04$  in)  
Level with carburetor base

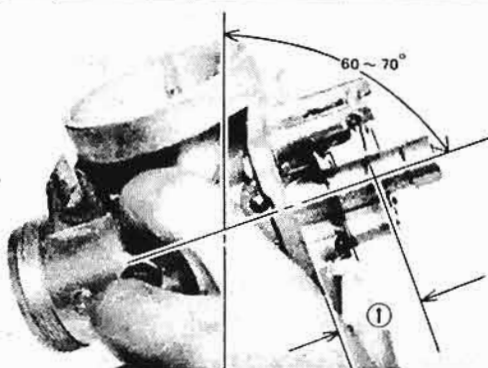

1. Float height

- b. Adjustment

**CAUTION:**

Check the needle valve and valve seat for wear before adjustment.

Make the adjustment by bending the tang on the float arm.

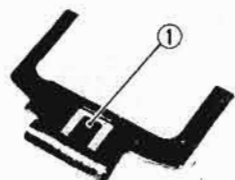

1. Tang

## 2. Jet needle adjustment

The mid-range air/fuel supply is affected by the position of the needle in the needle jet. If it is necessary to alter the mid-range air/fuel mixture characteristics of the machine, the jet needle position may be changed. Move the jet needle up for a leaner condition or toward the bottom position for a richer condition.

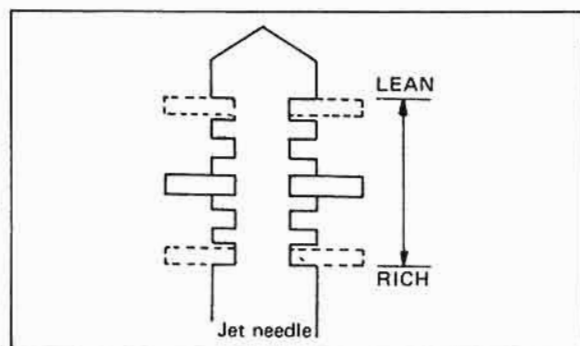

## Troubleshooting

A motocross machine requires immediate, predictable throttle response over a wide operating range. Cylinder porting, combustion chamber compression, ignition timing, muffler design, and carburetor size and component selection are all balanced to achieve this goal. However, variations in temperature, humidity and altitude will affect carburetion and consequently, engine performance.

The following list gives each of the major components of the carburetor that can be readily changed in order to modify performance if required. If you are unfamiliar with carburetor theory, we suggest you refrain from making changes. Quite often, a performance problem is caused by another related component, such as the exhaust system, ignition timing or combustion chamber com-

pression.

**NOTE:** See MECHANICAL ADJUSTMENTS for additional carburetor adjustments.

## Pilot air screw

Turning the screw in decreases the air supply, giving a richer mixture.

## Pilot jet

Changing the jet to one with a higher number supplies more fuel to the circuit giving a richer mixture.

## Throttle valve (slide)

Throttle valves are numbered according to the height of the cutaway. The higher the number, the larger the cutaway, the leaner the mixture.

## Jet needle

Moving the needle clip from the first, or top groove, to the fifth, or bottom groove, will give a correspondingly richer mixture.

## Main jet

Changing the jet to one with a higher number supplies more fuel to the main nozzle giving a richer mixture.

**NOTE:** Excessive changes in main jet size can affect performance at all throttle position.

**CAUTION:** The fuel/air mixture ratio is a governing factor upon engine operating temperature. Any carburetor changes, whatsoever, must be followed by a thorough spark plug test.

## REED VALVE

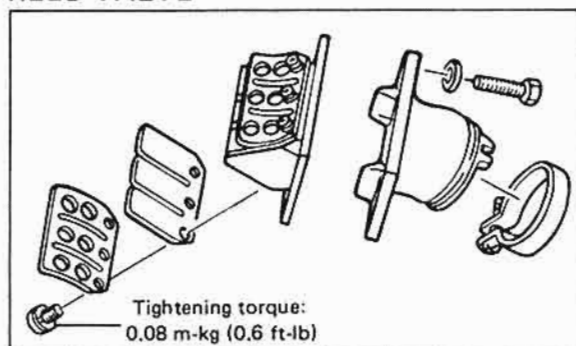

## Inspection

1. Inspect rubber intake manifold for signs of weathering, cracking or other deterioration.
2. Inspect reed petals for signs of fatigue and cracks. Reed petals should fit flush or nearly flush against neoprene seats. If in doubt as to sealing ability, apply suction to carburetor side of assembly. Leakage should be slight to moderate.
3. The valve stopper controls the movement of the valve. Check clearance "a".

Standard value "a":

7 mm (0.28 in)

If it is 0.2 mm (0.008 in) more or less than specified, replace the valve stopper.

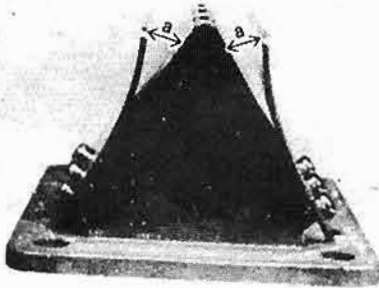

4. Check reed valve for bending. If beyond tolerance, replace reed valve.

Reed valve bending limit:

1.4 mm (0.055 in)

5. During reassembly, note the cut in the lower corner of the reed and stopper plate. Use as aid to direction of reed installation.

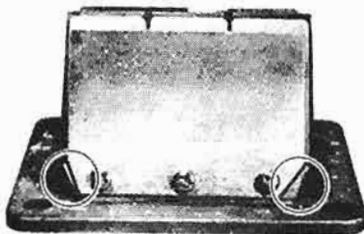

## MUFFLER

### Removal

1. Remove the two bolts and remove side cover.
2. Remove muffler and silencer mounting bolts and screw.
3. Remove coil springs at muffler to cylinder joint and remove muffler.

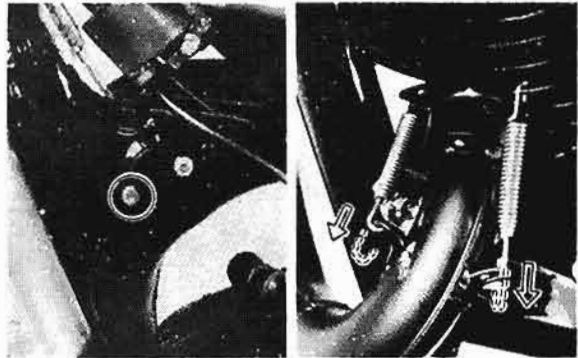
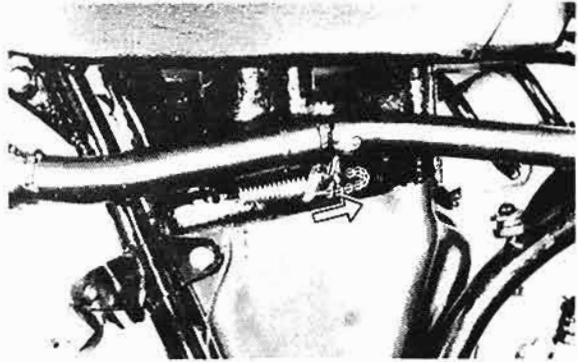

### Maintenance

1. Using a rounded scraper, remove excess carbon deposits from manifold area of exhaust pipe.
2. Carbon deposits within the silencer may be removed by lightly tapping the outer shell with a hammer and then blowing out with compressed air. Heavy wire, such as a coat hanger, may be inserted to break loose deposits. Use care.
3. Check the exhaust pipe for cracks. If it has excessive cracks, replace it.

## TOP END

(Muffler and carburetor are removed.)

### Removal

1. Remove spark plug lead wire. Loosen, but do not remove spark plug.
2. Remove the cylinder head holding nuts. Remove cylinder head and gasket.

Cylinder head nut:  
2.5 m-kg (18 ft-lb)



3. Remove the clutch wire.

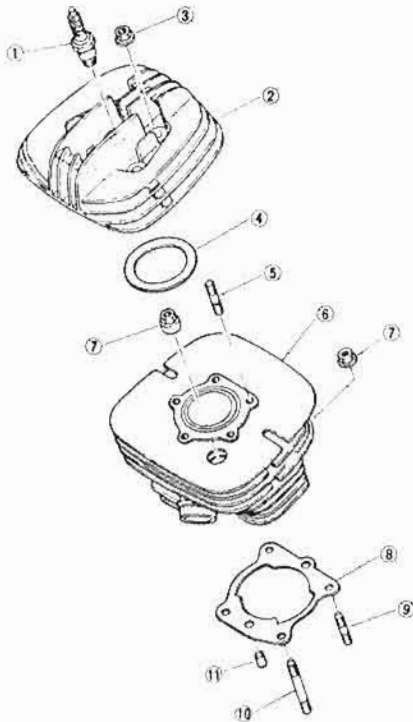
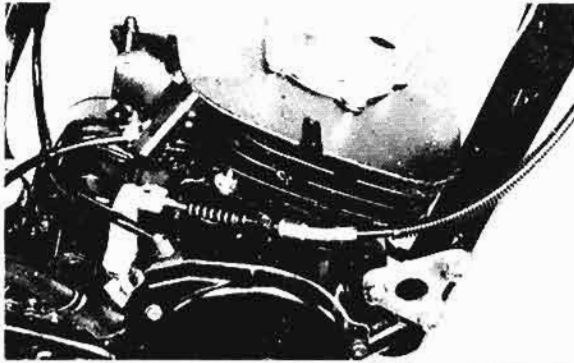

- |                         |                         |
|-------------------------|-------------------------|
| 1. Spark plug           | 7. Cylinder holding nut |
| 2. Cylinder head        | 8. Cylinder gasket      |
| 3. Nut                  | 9. Stud bolt            |
| 4. Cylinder head gasket | 10. Stud bolt           |
| 5. Stud bolt            | 11. Dowel pin           |
| 6. Cylinder             |                         |

4. Remove cylinder holding nuts (4).  
With the piston at top dead center, raise the cylinder until the cylinder skirts clear the crankcase. Stuff a clean shop rag into crankcase cavity, around rod, to prevent dirt and other foreign particles from entering. Remove cylinder and base gasket.

Cylinder holding nut:  
3.0 m-kg (22 ft-lb)

5. Remove the piston pin clip (1) from the piston. Push the piston pin out from opposite side. Remove the piston.

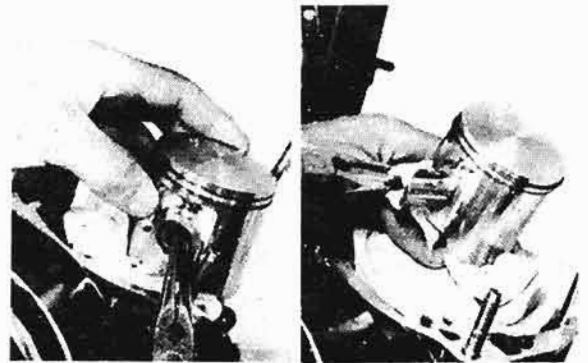

**NOTE:**

If the pin hangs up, use a piston pin puller. Do not hammer on pin as damage to rod, piston and bearing will result.

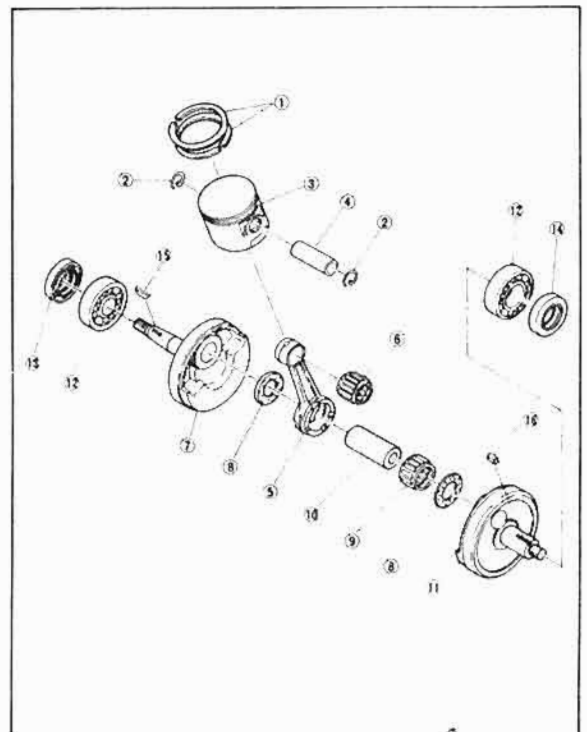



- |                      |                            |
|----------------------|----------------------------|
| 1. Piston ring       | 9. Con-rod big end bearing |
| 2. Circlip           | 10. Crank pin              |
| 3. Piston            | 11. Crank left             |
| 4. Piston pin        | 12. Bearing                |
| 5. Connecting rod    | 13. Oil seal               |
| 6. Small end bearing | 14. Oil seal               |
| 7. Crank left        | 15. Woodruff key           |
| 8. Washer            | 16. Straight key           |

## MAINTENANCE

### Cylinder head

- Using a rounded scraper, remove carbon deposits from combustion chamber. Take care to avoid damaging the spark plug threads. Do not use a sharp instrument. Avoid scratching the metal surface.

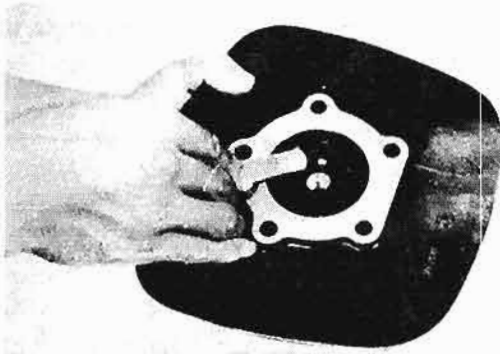

- Place the head on a surface plate. There should be no warpage. Correct by resurfacing. Place 400 ~ 600 grit wet emery sandpaper on surface plate and resurface head using a figure-eight sanding pattern. Rotate head several times to avoid removing too much material from one side.



### Cylinder

- Using a rounded scraper, remove carbon deposits from the exhaust port.

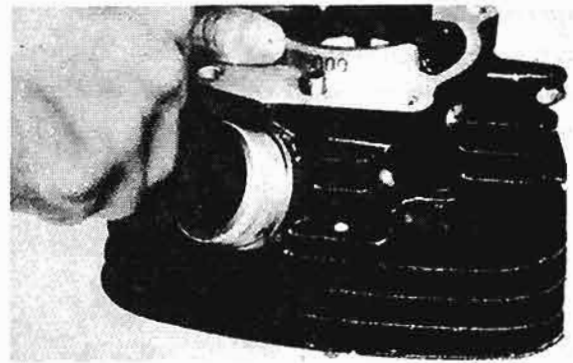

- Check cylinder bore. Using a cylinder hone, remove any scoring. Hone lightly, using smooth stones. Hone no more than required to avoid excess piston clearance.

### Piston

- Using a rounded scraper, remove carbon deposits from piston crown and ring grooves.

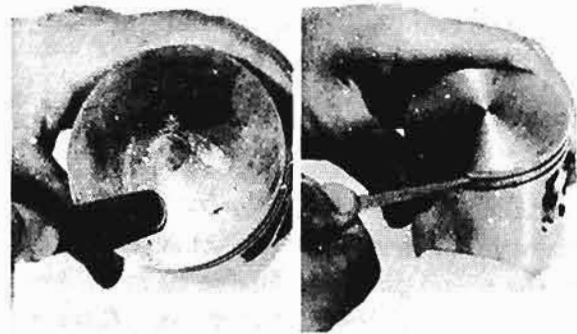

- Using 400 ~ 600 grit wet sandpaper, lightly sand score marks and lacquer deposits from sides of piston. Sand in crisscross pattern. Do not sand excessively.





## PISTON CLEARANCE

### Cylinder bore measurement

Using a cylinder gauge set to standard bore size, measure the cylinder. Measure front-to-rear and side-to-side at top, center and bottom just above exhaust port.

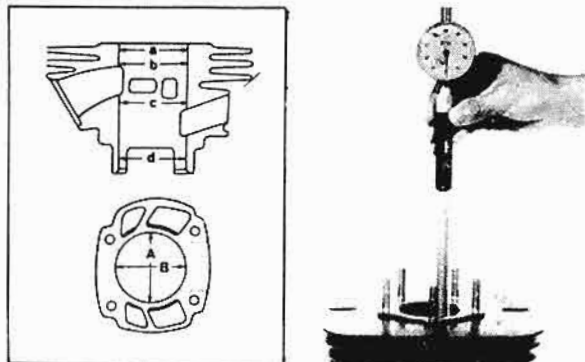

Compare minimum and maximum measurements. If over tolerance and not correctable by honing, rebores to next oversize.

Max. allowable taper:

0.08 mm (0.0031 in)

Max. allowable out-of-round:

0.05 mm (0.0020 in)

### Piston outside diameter measurement

Using an outside micrometer, measure piston diameter. The measuring point at right-angles to the piston pin holes, 18 mm (0.71 in) from the bottom of the piston skirts. Compare piston diameter to cylinder bore measurements (two measurements at right angles to piston pin line).

Do not try to measure from one of the intake "fingers" to the exhaust skirt. The piston will appear to be undersize. This is due to piston cam ground.

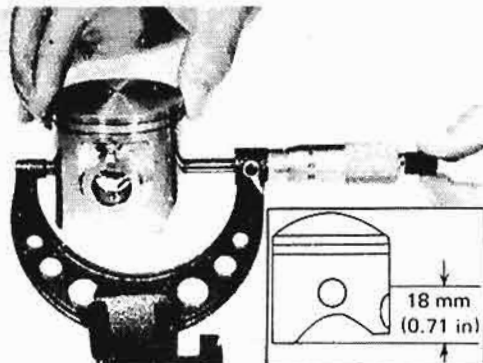

PISTON CLEARANCE =

Minimum	Maximum
Cylinder Diameter – Piston Diameter	

56.030 mm – 55.985 mm = 0.045 mm

If beyond tolerance replace piston or rebores cylinder as required.

Nominal piston clearance

0.045~ 0.050 mm (0.0018~ 0.0020 in)

### Piston rings

1. Insert ring into cylinder. Push down approximately 20 mm (0.787 in) using piston crown to maintain right-angle to bore. Measure installed end gap. If beyond tolerance, replace.

Ring end gap installed

0.3~ 0.5 mm (0.012~ 0.020 in)

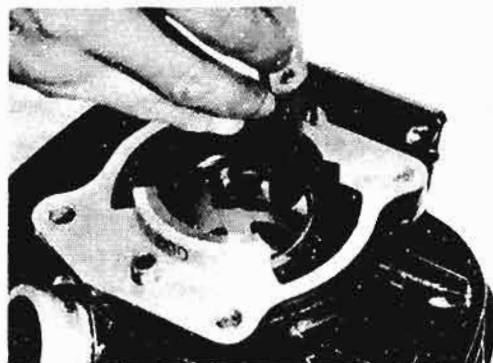

2. Holding cylinder towards light, check for full seating of ring around bore. If not fully seated, check cylinder. If cylinder is not out-of-round, replace piston ring.
3. Fit the piston rings in the grooves, and measure the side clearance. If it measures more than 0.1 mm (0.004 in), replace both piston and piston rings as an assembly.

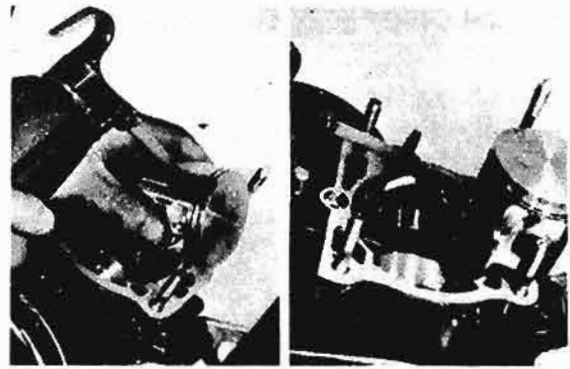
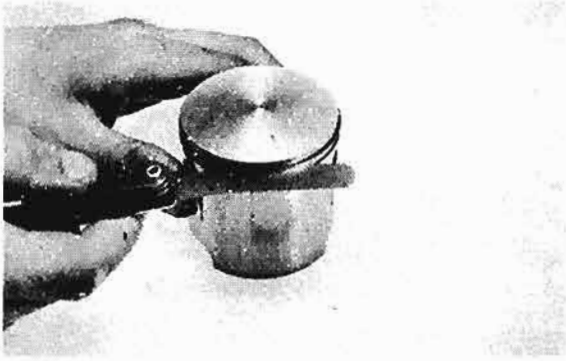

4. During installation, make sure ring ends are properly fitted around ring locating pin in piston groove. Apply liberal coating of two-stroke oil to ring.

**NOTE:** \_\_\_\_\_  
New ring requires break-in. Follow first portion of new machine break-in procedure.  
\_\_\_\_\_



#### **Piston pin, bearing**

1. Apply a light film of oil to pin and bearing surfaces. Install in connecting rod small end. Check for play. There should be no noticeable vertical play. If play exists, check connecting rod small end diameter for wear. Replace pin and bearing or both as required.
2. During reassembly, apply a liberal coating of two-stroke oil to the piston pin and bearing. Apply several drops of oil to the connecting rod big end. Apply several drops of oil into each crankshaft bearing oil delivery hole.

## CLUTCH

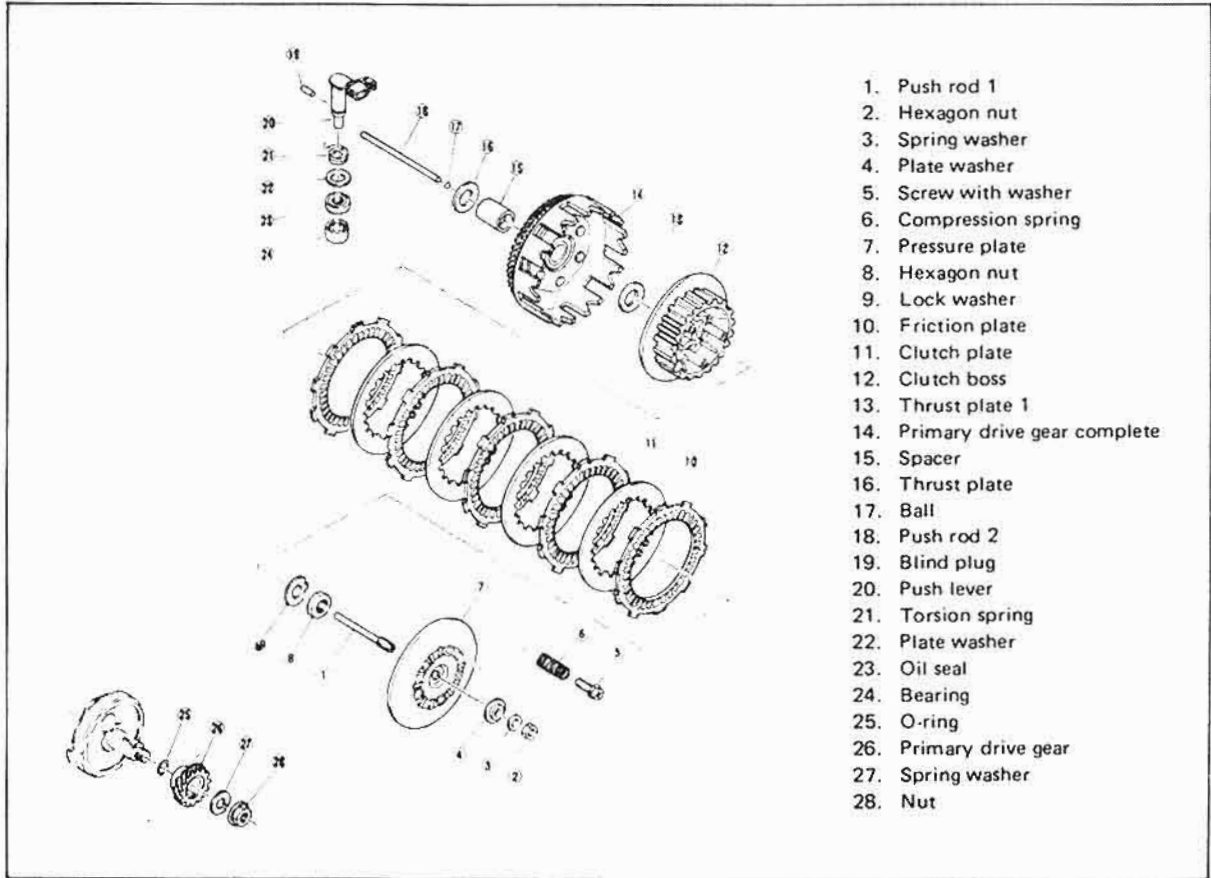

**NOTE:** \_\_\_\_\_  
 Clutch adjustment is covered in "Adjustments."

### Removal

1. Remove the oil plug and drain plug, and drain the transmission oil.
2. Footrest holds with two bolts, remove rear one and loosen the front one. Remove the change pedal.
3. Remove the allen bolts holding the side cover in place and remove the cover. Note the position of the dowel pins.

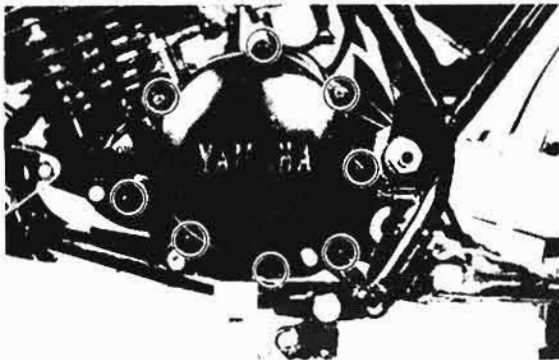

4. Remove the phillips screws (5) holding the pressure plate. Remove the clutch springs, pressure plate and push rod. Remove the clutch plates and friction plates.

**NOTE:** \_\_\_\_\_  
 When removing phillips spring screws, loosen each screw in several stages working in a crisscross pattern to avoid any unnecessary warpage. Note the condition of each piece as it is removed and its location within the assembly.

5. Bend lock washer tab down. Using the clutch holding tool, remove the clutch securing nut and lock washer. Remove the clutch boss and driven gear (clutch housing).

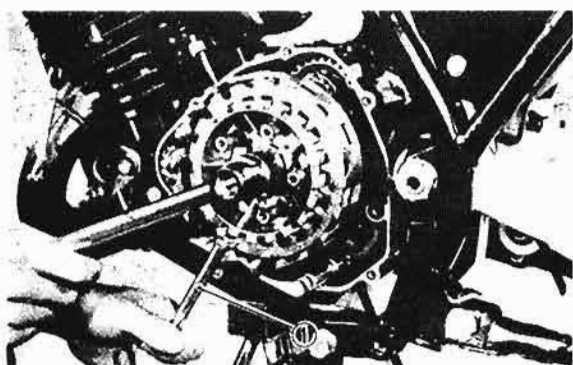

1. Clutch holding tool (90890-01022)

Clutch lock nut torque:  
5.0 m-kg (36 ft-lb)

Primary drive gear nut torque:  
6.0 m-kg (44 ft-lb)

6. If the clutch housing spacer remains on the transmission main shaft, remove it. Remove the thrust plate and thrust plate spacers.

#### Troubleshooting

1. Measure the friction plates at three or four points. If their minimum thickness exceeds tolerance, replace.

	New	Wear limit
Friction plate thickness	3.0 mm (1.12 in)	2.7 mm (0.106 in)

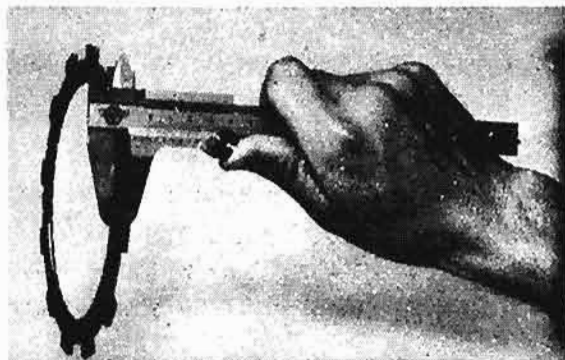

2. Check the plates for signs of warpage and heat damage, replace as required.

#### NOTE:

For optimum performance, if any plate requires replacement, it is advisable to replace the entire set.

3. Check each clutch plate for signs of heat damage and warpage. Place on surface plate (plate glass is acceptable) and use feeler gauge as illustrated. If warpage exceeds tolerance, replace.



Clutch plate warpage allowance:  
0.05 mm (0.002 in) Maximum

4. Check dogs on driven gear (clutch housing). Look for cracks and signs of galling on edges. If moderate, deburr. If severe, replace.

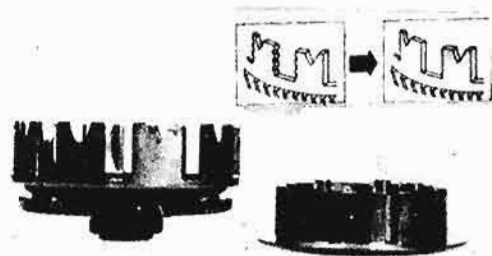

5. Measure each clutch spring. If beyond tolerance, replace.

	New	Min.
Clutch spring free length	36 mm (1.42 in)	35 mm (1.38 in)

#### NOTE:

For optimum clutch operation it is advisable to replace the clutch springs as a set if one or more are faulty.

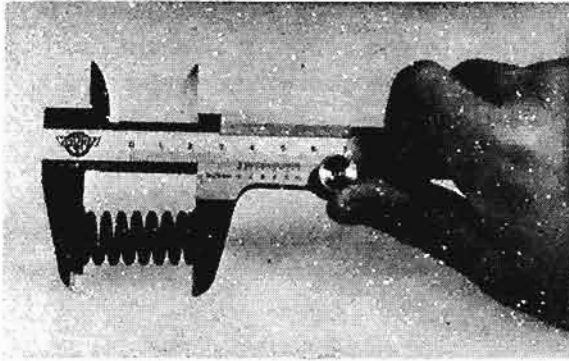

- Roll the push rod across a surface plate. If rod is bent, replace.

Bend limit: 0.15 mm (0.006 in)

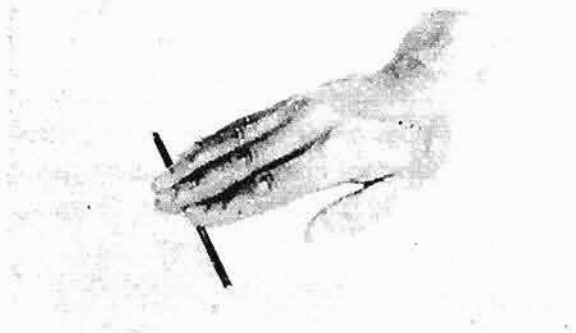

## KICK STARTER

### Removal

- Remove the circlip and then remove kick idle gear, washers and circlip.

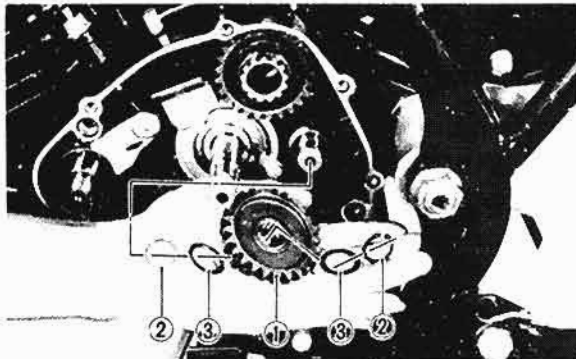

1. Kick idle gear 2. Circlip 3. Washer

- Remove the circlip and retainers. Remove the kick gear by rotating the kick crank counterclockwise and then pulling out the gear.

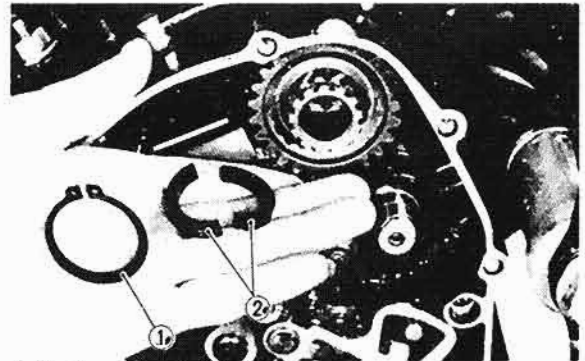

1. Circlip 2. Retainers

### Inspection

- The pressure of the kick clip is 1.0 kg (2.2 lb).

If above pressure is too strong, spring wear and kick starter slipping will result. If it is too weak, the same slippage will occur particularly at low temperatures. Do not try to bend the clip.

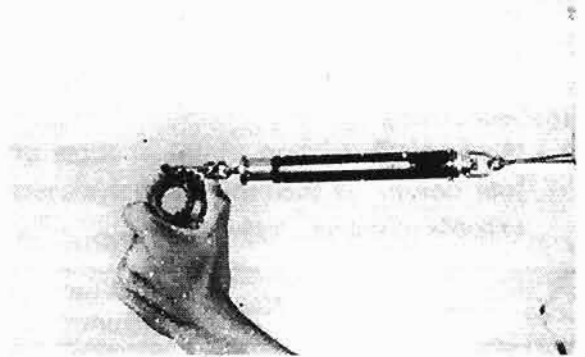

- Check the clip for damage and wear, and determine whether or not, it should be replaced.
- Check the gear teeth for wear and breakage.

### Reassembly

- Engage the kick gear return spring with the slot the slot of the crankcase. Check whether the kick starter acts correctly and whether it returns to its home position.





2. After installing the kick ass'y be sure to check whether it operates smoothly or not.

## SHIFTER

### NOTE:

Shifter maintenance should be performed with clutch assembly removed.

### Removal

1. Pull out change lever assembly.

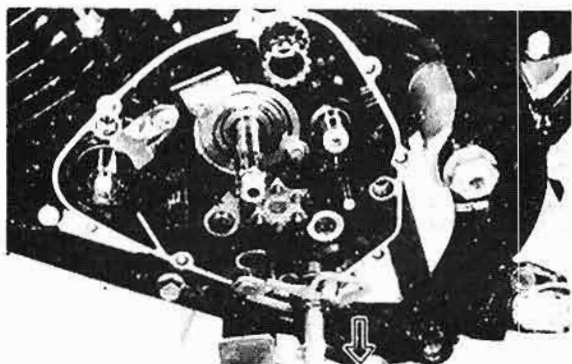

2. Remove the flange bolt, stopper lever and spring.

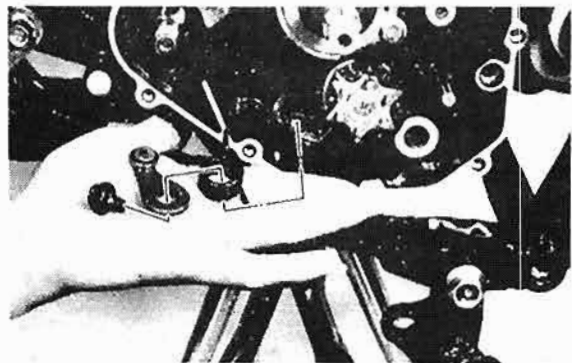

3. Remove the flat head screw and remove the shift cam and straight key.

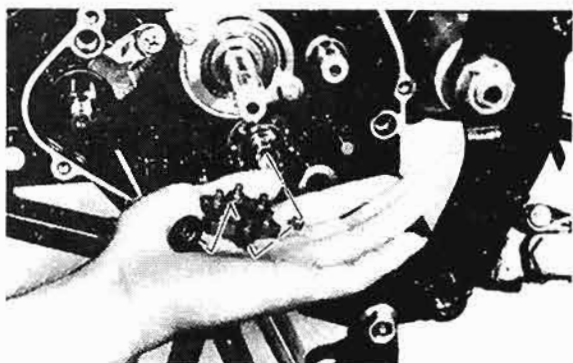

### Inspection

1. Inspect shift return spring. A broken or worn spring will impair the return action of the shifting mechanism.
2. Inspect change shaft assembly for bending of shaft, worn or bent splines, and broken or worn shift arm spring. A bent shaft will cause hard shifting.

### Installation

1. Apply a holding agent, such as "Loc-Tite", to threads of flat head screw.
2. Engage the shift return spring with its home position.

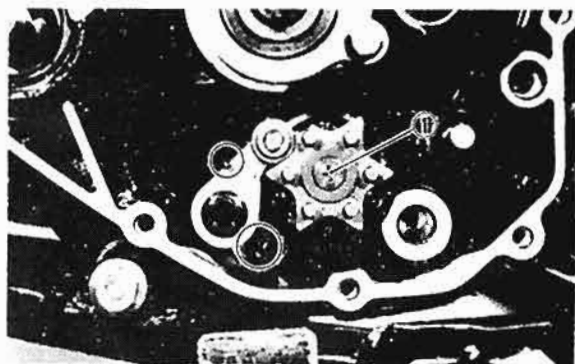

1. Apply a holding agent

## CRANKCASE

### Engine removal

1. Remove the magneto base, and chain cover.
2. Remove the chain and two engine mounting bolts.



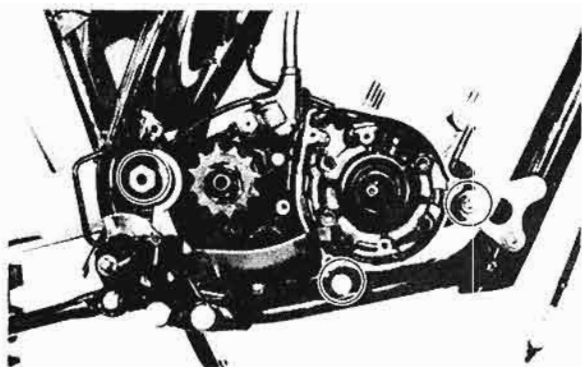

3. Remove the nut and pull out the pivot shaft about 2/3 of its length.

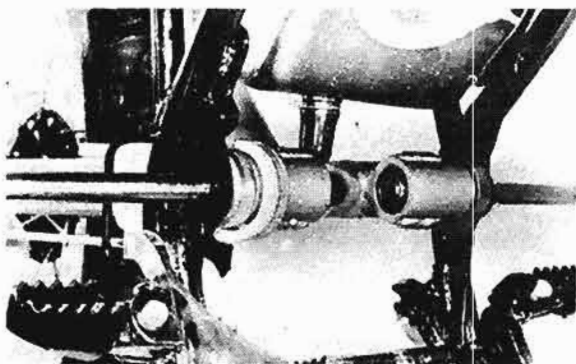

**NOTE:** \_\_\_\_\_

Do not pull it all the way out, or the swing arm will come off the frame.

4. Remove the engine from right side of frame.
5. Working in a crisscross pattern, loosen 10 panhead screws 1/4 turn each. Remove them after all are loosened.

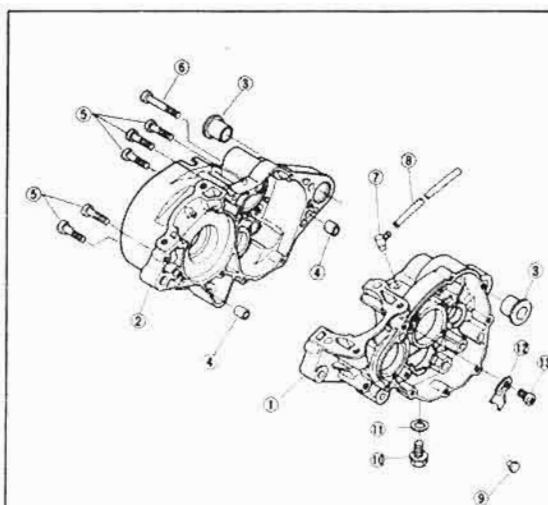
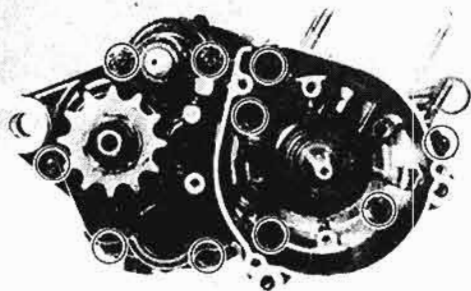

- |                    |                 |
|--------------------|-----------------|
| 1. Crankcase left  | 8. Hose         |
| 2. Crankcase right | 9. Plug         |
| 3. Spacer          | 10. Drain screw |
| 4. Dowel pin       | 11. Gasket      |
| 5. Panhead screw   | 12. Holder      |
| 6. Panhead screw   | 13. Screw       |
| 7. Breather        |                 |

6. Remove the oil seal retainer and plug. Install crankcase separating tool as shown.

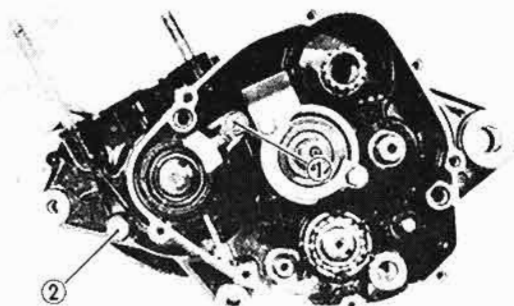

1. Retainer
2. Plug

**NOTE:** \_\_\_\_\_

Tighten the securing bolts on the crankcase separating tool, but make sure the tool body is parallel with the case. If necessary, one screw may be backed out slightly to level tool body.

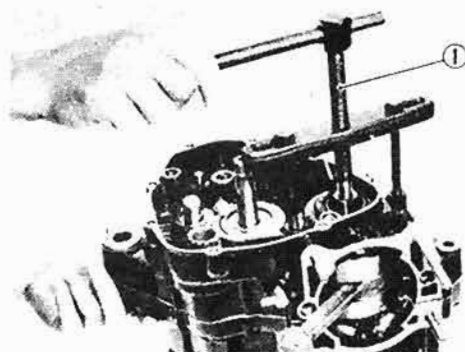

1. Crankcase separating tool

**CAUTION:**

Use a soft hammer to tap on the case half. Tap only on reinforced portions of case. Do not tap on gasket mating surface. Work slowly and carefully. Make sure the case halves separate evenly. If one end "hangs up", take pressure off the push screw, realign and start over. If the halves are reluctant to separate, check for a remaining case screw or fitting. Do not force.

- 7 Remove the circlip and unhook the torsion spring from its post in the crankcase. Then remove the torsion spring. Pull out the kick axle assembly from other side.

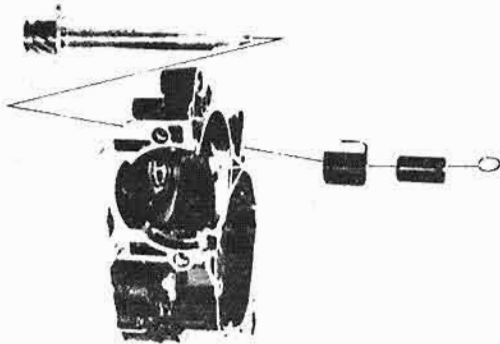
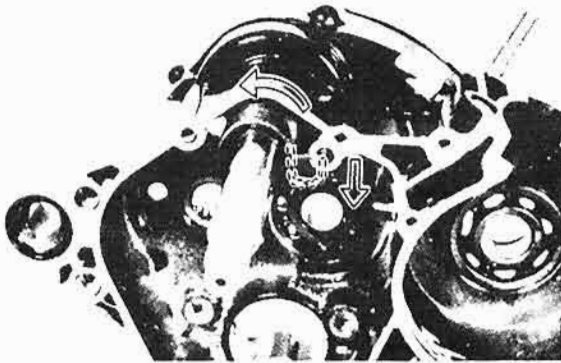

8. When installing the kick axle assembly, hook the torsion spring end to the hole of crankcase.

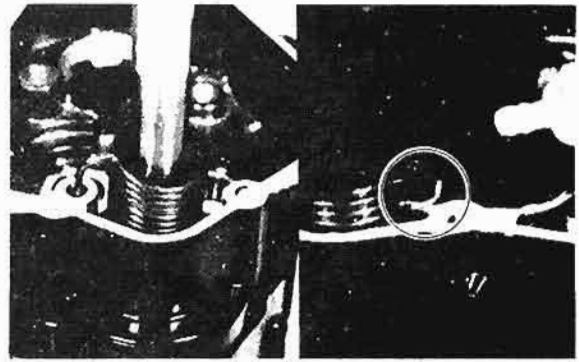
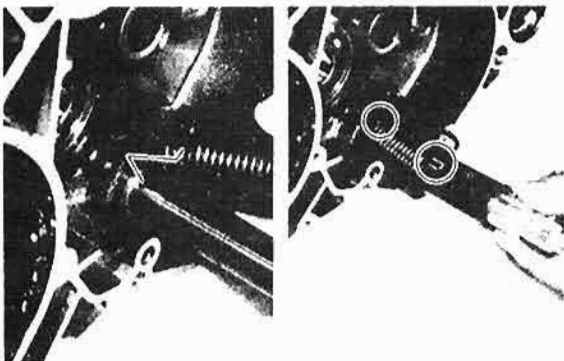

**Crankshaft**

1. Remove crankshaft assembly with crankcase separating tool.

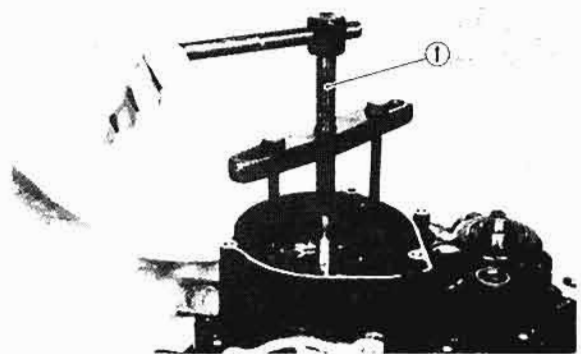

1. Crankcase separating tool

**Inspection**

1. The crankshaft requires the highest degree of accuracy in engineering and servicing.
2. The crankshaft is susceptible to wear and therefore the crank bearing must be inspected with special care.
3. Check crankshaft components.
  - a. Mount the dial gauge at right angles to the connecting rod small end, holding the bottom of rod toward the dial indicator. Rock top of rod and measure axial play.

Connecting rod axial play (C):  
0.8 ~ 2.0 mm (0.031 ~ 0.079 in)

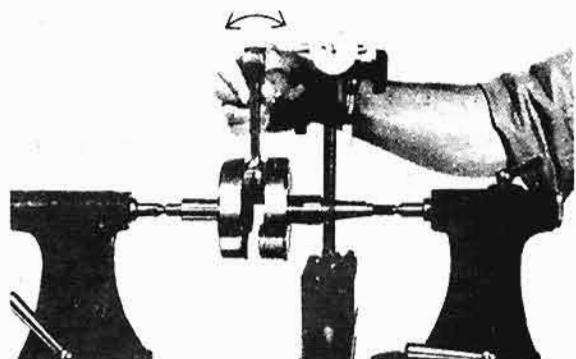

- b. Remove the dial gauge and slide the connecting rod to one side. Insert a thickness gauge between the side of the connecting rod big end and the crank wheel. Measure clearance.

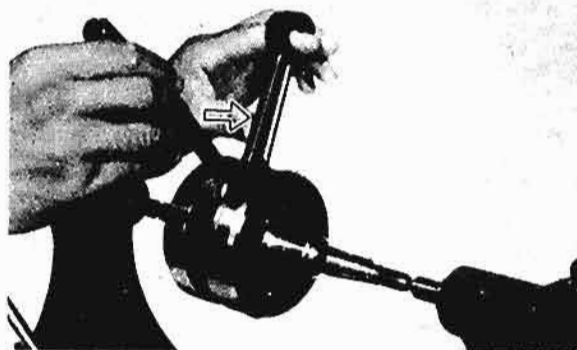

Connecting rod/crank side clearance (D):  
0.20 ~ 0.70 mm (0.008 ~ 0.028 in)

- c. If any of the above measurements exceed tolerance, crankshaft repair is required. Take the machine to your Authorized Yamaha Dealer.

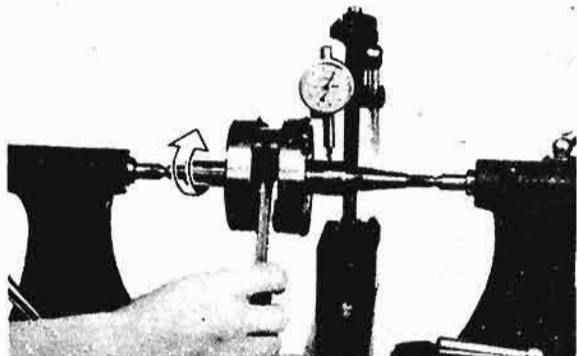

Unit: mm (in)

Deflection tolerance (A)		Flywheel width (B)
Left side	Right side	
0.03 (0.0012)	0.03 (0.0012)	56 <sup>-0.05</sup> <sub>-0.10</sub> mm
		(2.205 <sup>-0.002</sup> <sub>-0.004</sub> in)

### Crankshaft installation

1. Set the crankshaft into right case half and install with a crankshaft installing tool.

#### CAUTION:

To protect the crankshaft against scratches or to facilitate the operation of installation: Pack the oil seal lips with grease. Apply engine oil to each bearing.

2. Hold the connecting rod at top dead center with one hand while turning the handle of the installing tool with the other. Operate tool until crankshaft bottoms against bearing.

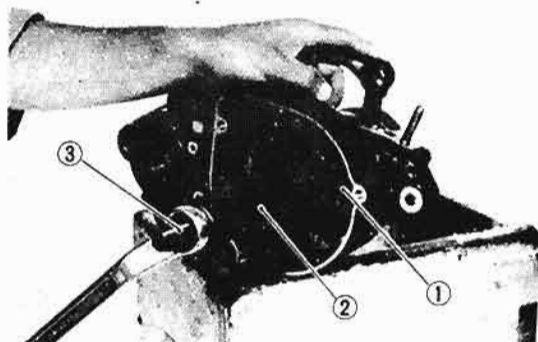

1. Adapter
2. Crankshaft installer pot
3. Crankshaft installer bolt

### Bearings and oil seals

1. After cleaning and lubricating the bearings, rotate inner race with a finger. If rough spots are noticed, replace the bearing.

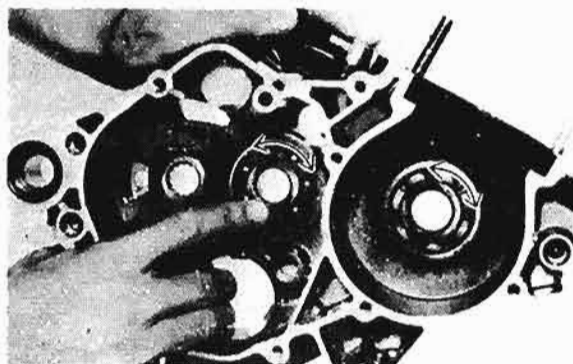

#### NOTE:

Bearing(s) are most easily removed or installed if the cases are first heated to approximately 90° ~ 120°C (194° ~ 248°F). Bring the case up to proper temperature slowly. Use an oven.

2. Check oil seal lips for damage or wear. Replace as required.
3. Always replace crankshaft oil seals whenever the crankshaft is removed.
4. Install bearing(s) and oil seal(s) with their manufacturer marks or numbers facing outward. Before installation, apply grease to oil seal lip(s) and bearing(s).

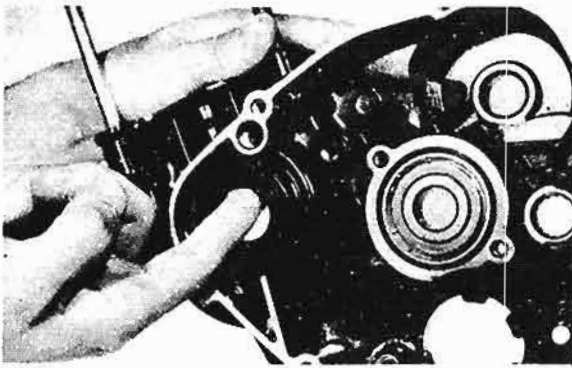

### Transmission

1. Tap lightly on the transmission drive shaft with a soft hammer to remove.

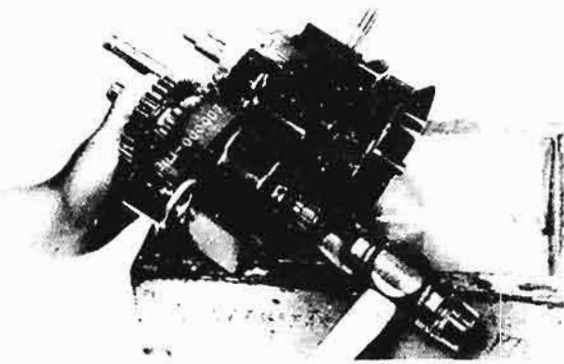

### NOTE:

Remove assembly carefully. Note the position of each part. Pay particular attention to the location and direction of shift forks.

### Inspection

1. Inspect each shift fork for signs of galling on gear contact surfaces. Check for bending. Make sure each fork slides freely on its guide bar.
2. Roll the guide bars across a surface plate. If any bar is bent, replace it.

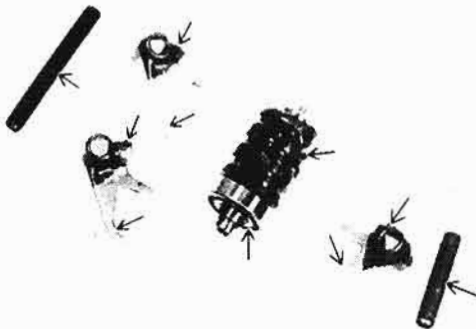

3. Check the shift cam grooves for signs of wear or damage. If any profile has excessive wear and/or any damage, replace cam.
4. Check the cam followers on each shift fork for wear. The follower should fit snugly into its seat in the shift fork, but should not be overly tight. Check the ends that ride in the grooves in the shift cam. If they are worn or damaged, replace them.
5. Check shift cam dowel pins and side plate for looseness, damage, or wear. Repair as required, or replace.
6. Check the shift cam stopper plate, circlip, stopper for wear.
7. Check the transmission shafts using a centering device and dial gauge. If any shaft is bent, replace it.

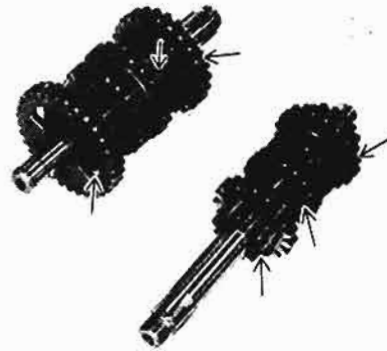

8. Carefully inspect each gear. Look for signs of obvious heat damage (blue discoloration). Check the gear teeth for signs of pitting, galling, or other extreme wear. Replace as required.
9. Check to see that each gear moves freely on its shaft.
10. Check to see that all washers and clips are properly installed and undamaged. Replace bent or loose clips and bent washers.
11. Check to see that each gear properly engages its counterpart on the shaft. Check the mating dogs for rounded edges, cracks, or missing portions. Replace as required.

## Installation

1. Check to see that all parts move freely and that all loose shims are in place. Make sure all shafts are fully seated.

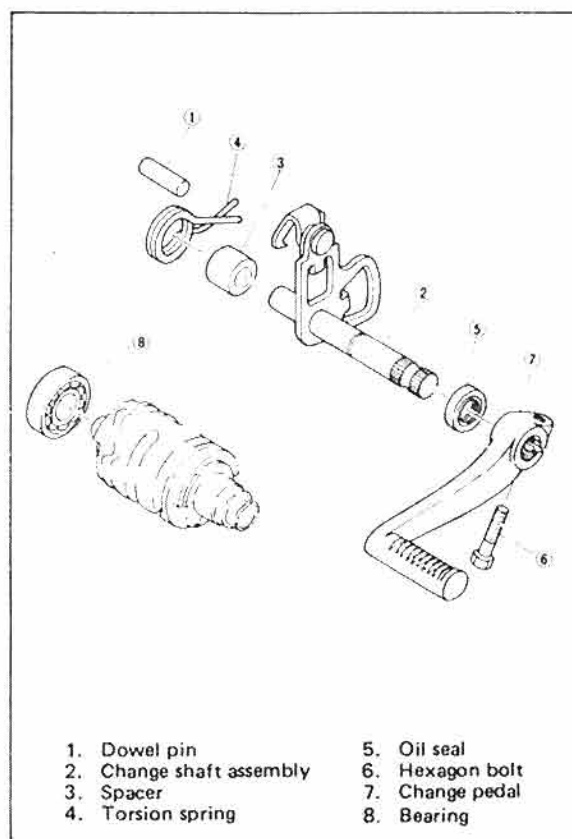
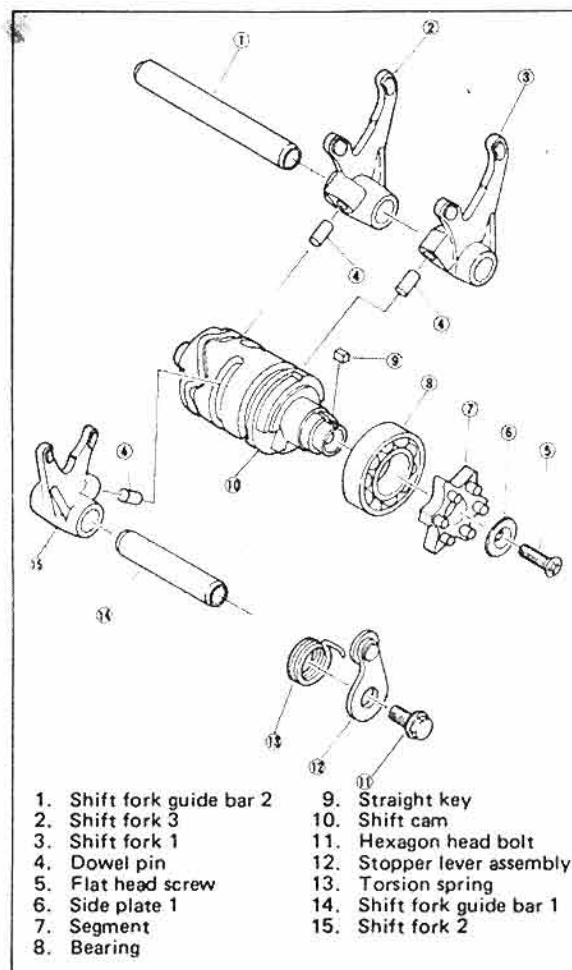
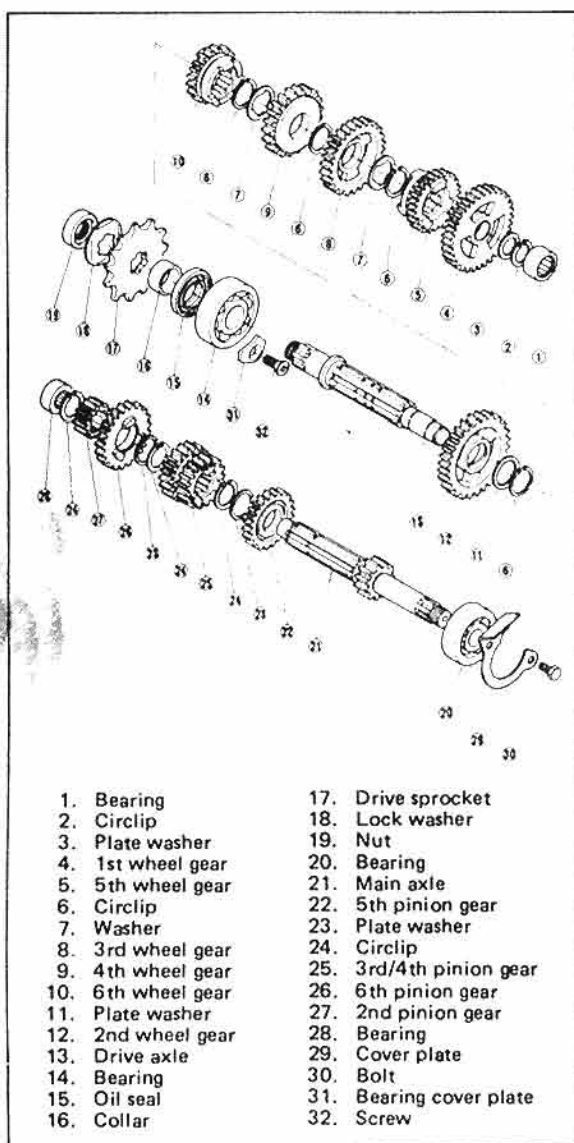
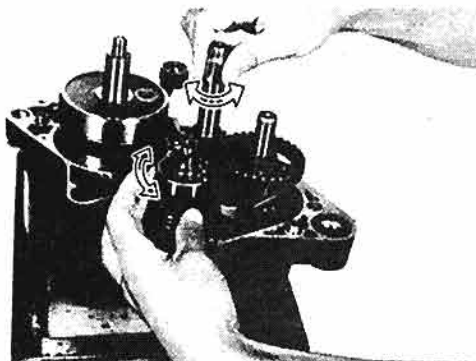



## Reassembling

1. Apply YAMAHA BOND # 4 to the mating surfaces of both case halves.

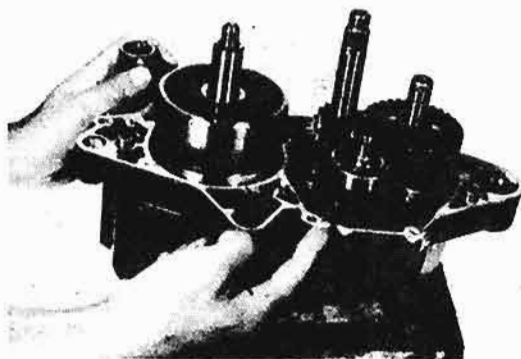

### NOTE:

- a. Do not tap on machined surface or end of crankshaft.
  - b. Before installing the crankshaft, check the crankshaft O-ring for damage.
2. After reassembly, apply a liberal coating of two-stroke oil to the crank pin and bearing and into each crankshaft bearing oil delivery hole.
  3. Check crankshaft and transmission shafts for proper operation and freedom of movement.
  4. During re-assembly, always use a new cylinder base gasket.

Cylinder nut torque:

3.0 m-k<sub>g</sub> (22 ft-lb)

Cylinder head nut torque:

2.5 m-k<sub>g</sub> (18 ft-lb)

5. During re-assembly, coat the piston skirt areas liberally with two-stroke oil.
6. Install new piston pin circlips and make sure they are fully seated within their grooves.
7. Take care during installation to avoid damaging the piston skirts against the crankcase as the cylinder is installed.

### NOTE:

The arrow on piston dome must face forward.

## Mounting

1. Install engine mounting bolts and nuts with proper tightening torque.

Bolt	Tightening Torque
Bracket to frame	3.0 m-k <sub>g</sub> (22 ft-lb)
Bracket to engine	3.0 m-k <sub>g</sub> (22 ft-lb)
Center, Lower	3.0 m-k <sub>g</sub> (22 ft-lb)

Pivot shaft nut:

8.5 m-k<sub>g</sub> (60 ft-lb)

2. Install drive sprocket.

Drive sprocket nut torque:

6.0 m-k<sub>g</sub> (42 ft-lb)

3. Install flywheel magneto.

Rotor nut torque:

3.5 m-k<sub>g</sub> (25 ft-lb)



# CHASSIS

## FRONT FORKS

### CAUTION:

To prevent an accidental explosion of air, the following instructions should be observed:

1. Use only air or nitrogen for filling. Never use any other gas. An explosion may result.
2. Never throw the air shock absorber into fire.
3. Before removing the air shock absorbers out from the front forks, be sure to extract the air from the air chamber completely.

## Air pressure adjustment

### CAUTION:

For proper damping effects, the sealed air pressure must be maintained at the following levels.

Both forks must have the same pressure.

1. Place a suitable stand under the engine to keep the front of machine raised off the floor. No weight on front wheel.
2. Using a manual air pump, fill with air.

### CAUTION:

The gas pressure should not exceed  $2.5 \text{ kg/cm}^2$ . Excess gas pressure will cause damage to the forks.

3. Using the air check gauge, adjust the air pressure to specification.

Standard air pressure:

$0 \text{ kg/cm}^2$  (0 psi)

### NOTE:

Each time the air gauge is inserted, the air pressure decreases about  $0.05$  to  $0.1 \text{ kg/cm}^2$ .



### NOTE:

When oil enters check gauge, thereby keeping the needle from returning to the original position, loosen the screw in the rubber at the gauge mouth, and shake the gauge several times to remove the oil inside. After making sure of the needle being at the original position, retighten the screw.

4. The difference between both right and left tubes should be  $0.1 \text{ kg/cm}^2$  ( $1.42 \text{ lb/in}^2$ ) or less.

## Fork oil replacement

1. Place a suitable stand under the engine to keep the front of machine raised off the floor.
2. Remove the rubber cap and valve cap.

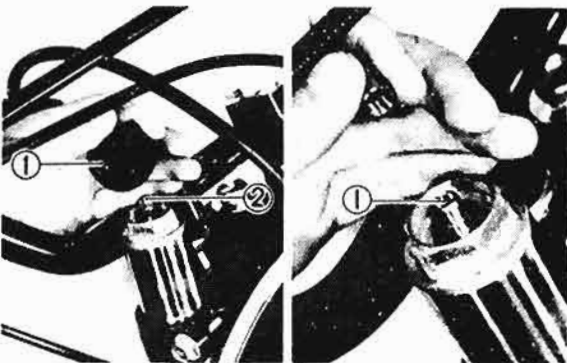

1. Rubber cap 2. Valve cap 1. Valve

3. Using a slotted-head screwdriver, press the valve and keep it open for more than 3 seconds so that the air can be let out from the inner tube.

### NOTE:

When the air has to be extracted from the tube extract little by little. If not, oil spouts out together with the air, causing harm to you.

- Remove the cap bolt assembly.  
And remove the spacer, spring seat and fork spring.
- Place an open container beneath each drain hole and remove the drain screws.



1. Drain screw

- After most of oil has drained, slowly raise and lower outer tubes to pump out remaining oil.
- Install drain screws.

**NOTE:** \_\_\_\_\_  
Check gasket, replace if damaged.

- Measure correct amount of oil and pour into each leg.

Recommended oil:  
Yamaha fork oil 10 wt or  
SAE # 10 oil  
Oil quantity: 360 cc (12.1 oz)

**NOTE:** \_\_\_\_\_  
Select the weight of oil that suits local conditions and your preference (lighter for less damping, heavier for more damping).

- Measure the oil level from top of the fork tube with a tape measure. The fork tubes must be fully bottomed.

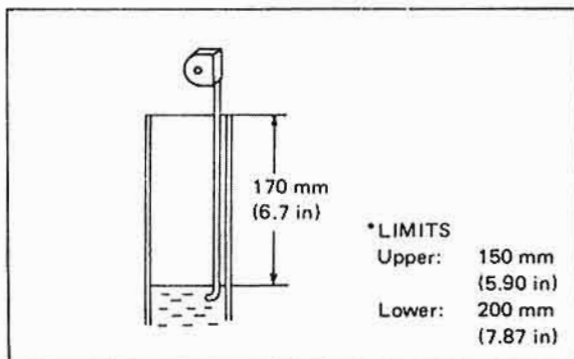

- After filling, slowly pump the outer tubes up and down to distribute the oil.
- Inspect the O-ring on cap bolt and replace if damaged.

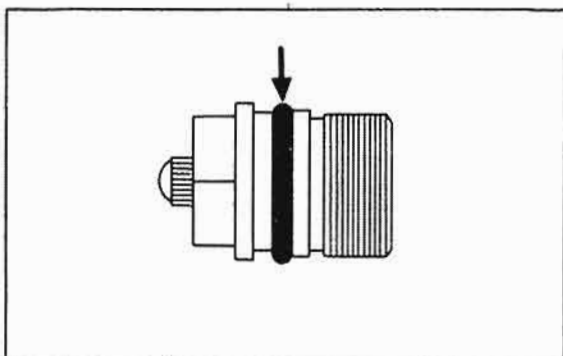

- Install spacer, spring seat, fork spring and cap bolt and torque to specification.

Tightening torque: 2.3 m-kg (16.5 ft-lb)

#### Front fork spring replacement

In addition to the standard type, two different type fork springs are sold. A proper spring should be selected according to the conditions of a racing course or the weight of the rider.

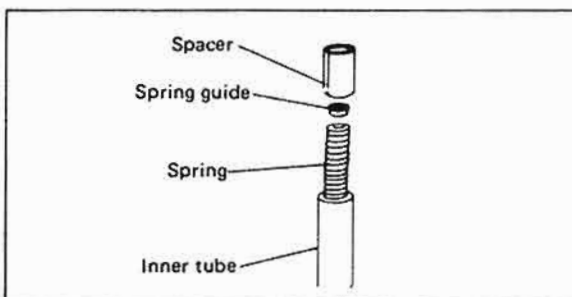

Type		Part No.	Spring rate (kg/mm)	I.D. mark
Light duty	Spring	3R3-23141-10	K = 0.268	
STD	Spring	3R3-23141-00	K = 0.217	
Heavy duty	Spring	3R3-23141-20	K = 0.357	

**NOTE:** \_\_\_\_\_  
Always check the oil levels before changing or re-installing springs.

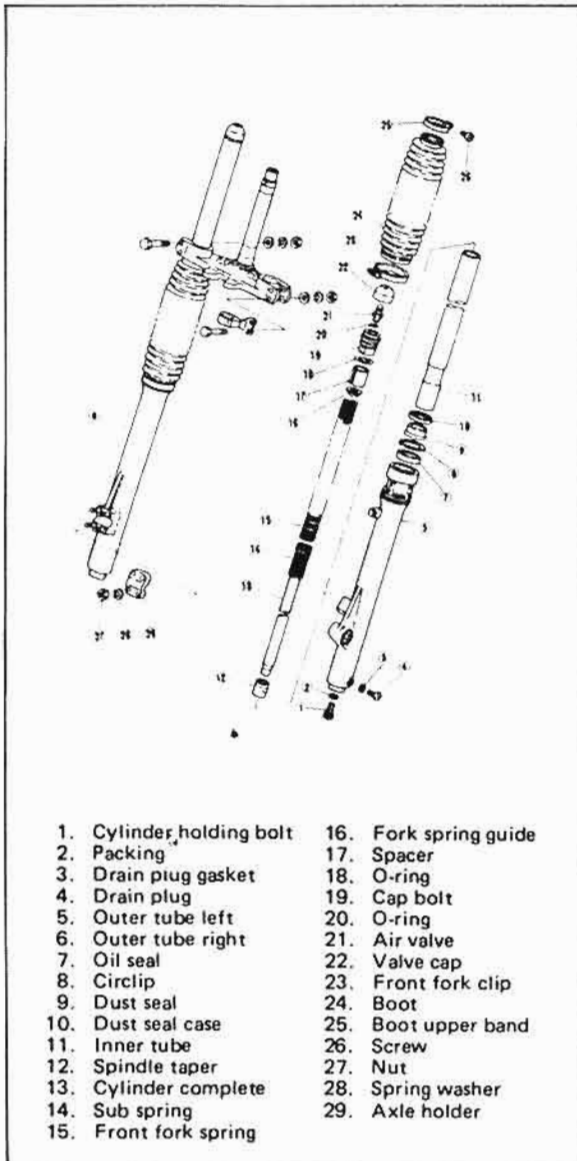

**Disassemble**

1. To disassemble the front fork assembly, remove the cylinder holding bolt from the bottom of the outer tube and pull the inner and outer tubes apart.

**NOTE:**

Use the fork spring guide wrench for removing the cylinder holding bolt.



**NOTE:**  
Apply a holding agent, such as "LOCTITE" to threads of bolt when assembling.

2. To replace the fork seal, remove the dust seal and pull out the dust seal case, with an appropriate tool like a bearing puller. Remove the snap ring with clip plier.

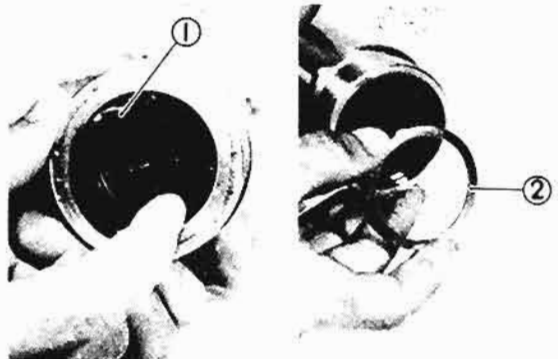

1. Dust seal                      2. Dust seal case



3. Carefully pry out the old seal without damaging fork tube.



4. Insert the new seal with "Open" side down (Manufacture's marks up) using large socket and hammer.

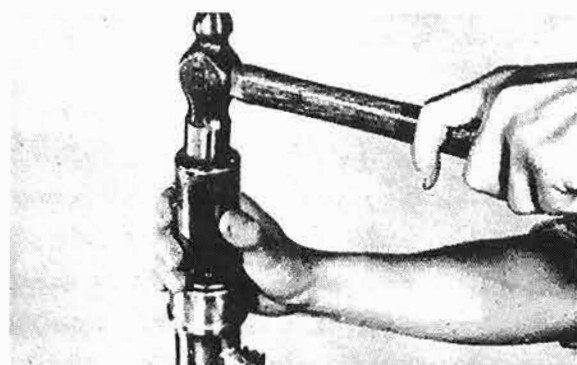

## REAR SHOCK ABSORBER (MONOCROSS SUSPENSION "DE CARBON" SYSTEM)

### —WARNING:—

This shock absorber is provided with a separate tank filled with high-pressure nitrogen gas. To prevent the danger of explosion, read and understand the following information before handling the shock absorber.

The manufacturer can not be held responsible for property damage or personal injury that may result from improper handling.

1. Never tamper or attempt to disassemble the cylinder or the tank. Never tamper with the nut securing the hose to the cylinder assembly; otherwise, oil will spurt from the cylinder due to the high pressure in the nitrogen gas tank.
2. Never throw the shock absorber into an open flame or other high heat source. The shock absorber may explode as a result of nitrogen gas expansion and/or damage to the hose.
3. Be careful not to damage any part of the gas tank. A damaged gas tank will impair the damping performance or cause a malfunction.
4. Use care not to damage any part of the hose. Any break in the hose may result in a spurt of oil under high pressure.
5. Take care not to scratch the contact surface of the piston rod with the cylinder or oil could leak out.
6. Never attempt to remove the plug at the bottom of the nitrogen gas tank. It is very dangerous to remove the plug.
7. When scrapping the shock absorber, follow the instructions on disposal.

## ADJUSTMENT

This machine's suspension is adjustable to best suit the rider's preference or road conditions. (For adjustment, refer to "Suspension Setting".

### — Break-in: —

For the first 300 km (200 mi) of operation, this suspension unit should be broken in. To afford better riding comfort, the monocross unit is set on a two steps softer side (red mark). After the break-in period, return the monocross unit to the standard position (yellow mark). If the standard position does not suit your preference or road condition, make a readjustment or other necessary adjustments.

\*The monocross unit is originally set so as to suit the standard rider.

### Damping performance

This adjustment can be done in 24 steps without removing the rear shock absorber.

- \* To make it stiffer, tighten the adjuster. (As illustrated, turn it clockwise.)
- \* To make it softer, loosen the adjuster. (Turn it counterclockwise.)

Adjustment should be made notch by notch and test it by riding after each adjustment.

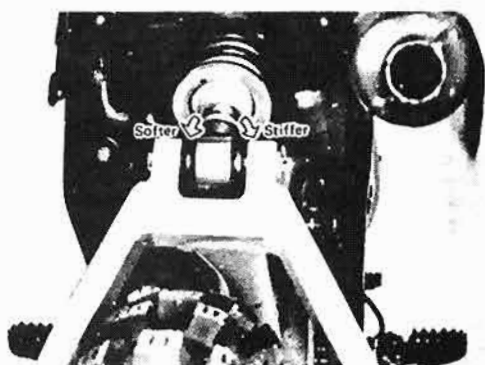

### NOTE: —

Turn the adjuster until it clicks. Stop turning the adjuster when it suddenly becomes heavy or light. Do not give any further turns. The adjustable range covers approximately 12 notches on each side from the standard position.

### Spring pre-load

To make an adjustment of the spring preload, use the special wrench (contained in the owner's tool kit).

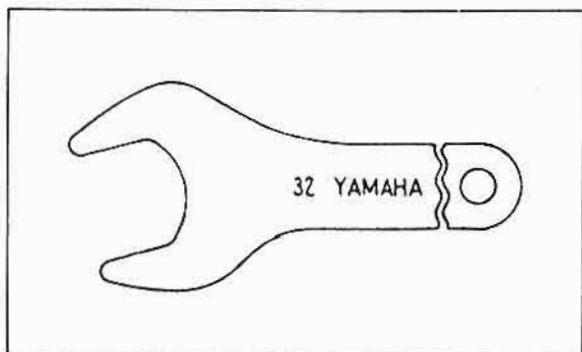

1. Loosen the adjuster lock nut.
2. To increase the spring pre-load, tighten the adjuster. To decrease, loosen the adjuster.

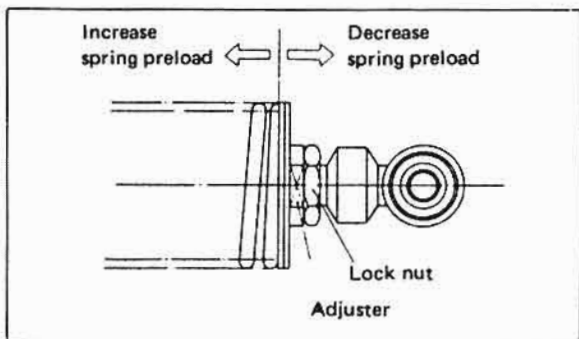

#### NOTE:

Adjustment should be made by tightening or loosening the adjuster 2 mm each time.

Standard Length (installed): 356 mm (14.0 in)

Minimum Length (installed): 345 mm (13.6 in)

Maximum Length (installed): 360 mm (14.2 in)

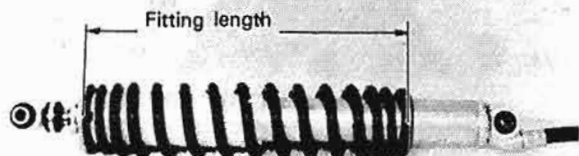

BE SURE THAT ADJUSTMENT IS WITHIN THE ABOVE RANGE.

3. After adjustment, tighten the lock nut.

Tightening torque: 6.5 m·kg (46 ft·lb)

### Spring replacement

In addition to the standard type, hard and soft springs are available and also the springs from the YZ250G can be used. If the standard type is improper for your purpose, select a proper one according to the rider's weight or road conditions.

Type	Part No.	Spring rate (kg/mm)	I.D.color
Light duty	3R3-22212-10	K1 = 1.7, K2 = 2.8	Green
Standard	3R3-22212-00	K1 = 1.8, K2 = 3.1	Red
Heavy duty	3R3-22212-20	K1 = 1.9, K2 = 3.6	Blue

Identification colors are shown on both ends of a spring.

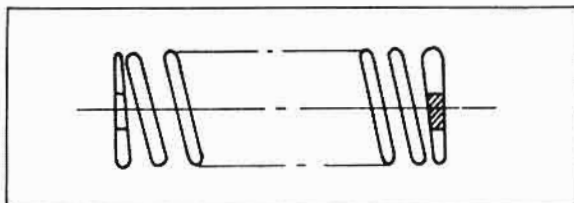

### Gas pressure adjustment

The nitrogen gas pressure is adjustable. For this adjustment, take the unit to your Authorized Yamaha dealer.

### Absorber removal

1. Place a suitable stand under the engine to raise the rear wheel off the ground.
2. Remove the seat and fuel tank (place the fuel petcock lever to "OFF" and disconnect fuel hose) and remove the rear wheel.

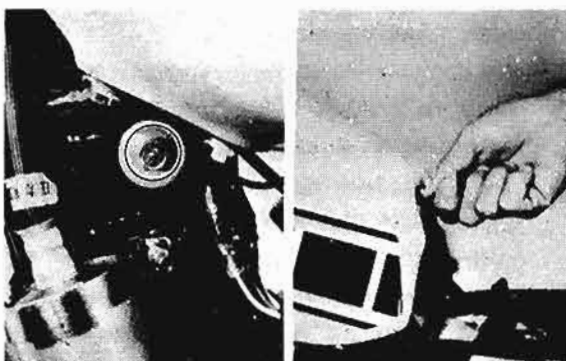



3. Remove the screw and remove the band holding the gas tank. Next, remove the gas tank from the grommet.

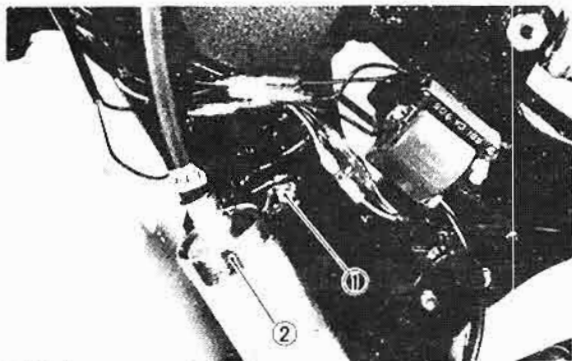

1. Fitting screw 2. Band

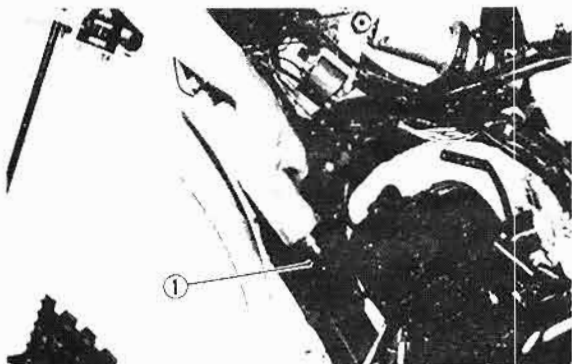

1. Grommet

4. Remove the cotter pin and nut from the bolt securing the upper part of shock absorber, and remove the bolt.

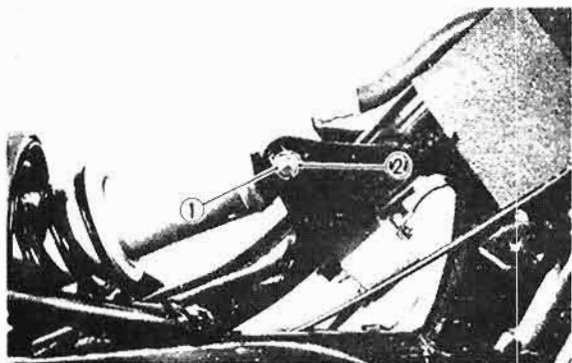

1. Cotter pin 2. Nut

5. Remove the cotter pin and washer from the pin securing the lower part of the shock absorber, and pull out the pin. (Be carefull so that the thrust washer is not lost.)

1. Panhead screw  
2. Damper sub assembly  
3. Bush  
4. Circlip  
5. Spring lower seat  
6. Dust seal  
7. Seal ring housing

8. Case cap  
9. Push rod  
10. Bump stopper  
11. Bump stopper support  
12. Spring  
13. Guide spring 2  
14. Guide spring 1

15. Spring upper seat  
16. Nut  
17. Cover  
18. Adjusting nut  
19. Cover  
20. Dowel pin

21. Bracket  
22. Bush  
23. Solid bush  
24. Bolt  
25. Plate washer  
26. Nut  
27. Cotter pin

28. Clevis pin  
29. Thrust cover  
30. Plate washer  
31. Cotter pin  
32. Sub tank holder  
33. Damper  
34. Spring washer  
35. Panhead screw

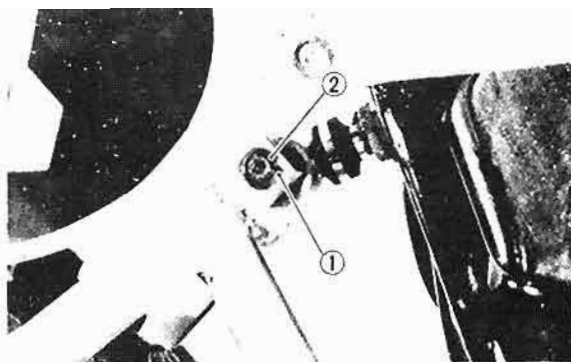

1. Cotter pin 2. Washer

6. Remove the shock absorber from the frame.

**NOTE:**

When removing the shock absorber, take the following precautions:

- Take care not to damage the gas tank.
- Do not damage the rubber hose.

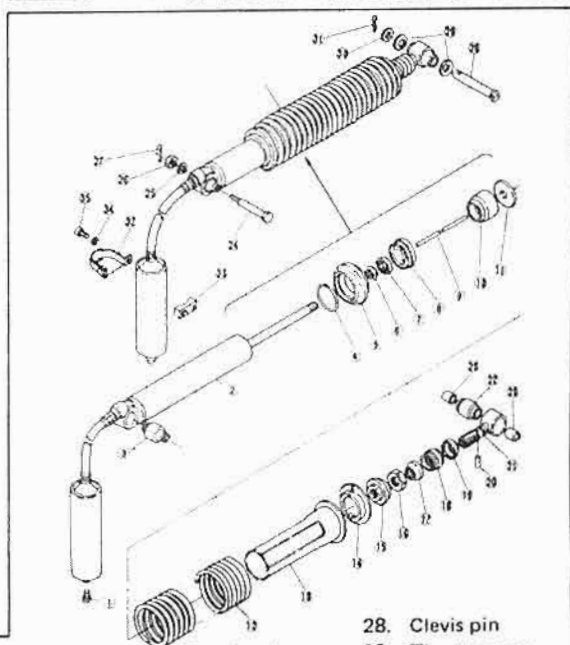
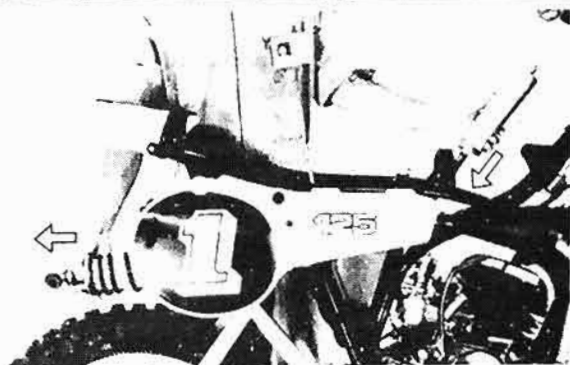



7. For assembly, reverse the procedure for disassembly while taking the following precautions:

- a. Be sure that the shock absorber is installed as illustrated.

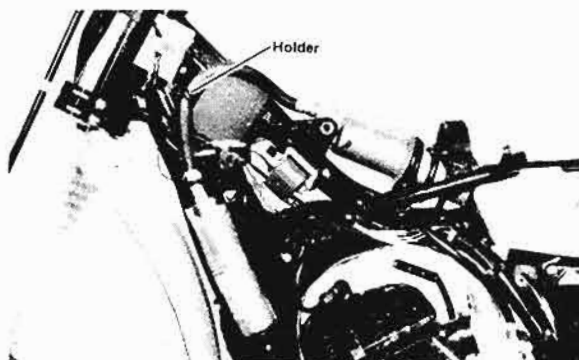

- b. Installing the shock absorber, make sure the locating damper is securely in place.  
 c. Always use a new cotter pin.  
 d. Grease the pin and thrust washer.  
 e. Tighten the nut to specification.

Upper bolt: 3.0 m-kg (22 ft-lb)

#### Notes on disposal (Yamaha dealers only)

Before disposing the shock absorber, be sure to extract the nitrogen gas. To do so, drill a 2 or 3 mm (0.08 ~ 0.12 in) hole through the tank at a position 15 ~ 20 mm (0.6 ~ 0.8 in) from the bottom end of the tank. At this time, wear eye protection to prevent eye damage from escaping gas and/or metal chips.

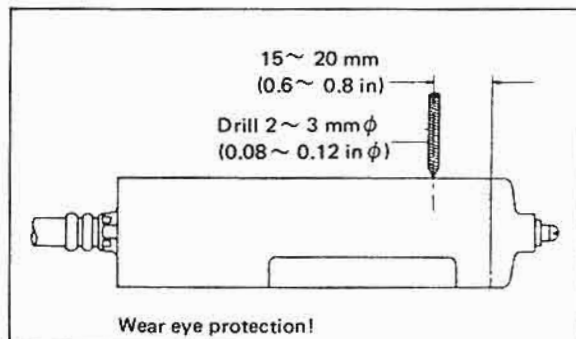

#### —WARNING:—

To dispose of a damaged or worn-out shock absorber, take the unit to your Yamaha dealer for this disposal procedure.

## SUSPENSION TUNING

#### —WARNING:—

READ AND UNDERSTAND ALL INSTRUCTIONS DEALING WITH SUSPENSION COMPONENTS. FAILURE TO FOLLOW INSTRUCTIONS AND GUIDELINES MAY RESULT IN DAMAGE TO MACHINE AND/OR INJURY TO A MECHANIC OR USER.

To solve any of the following problems, perform step 1; then test ride. If further improvement is needed, perform step 2 and follow it with a test ride. Proceed to step 3 if necessary.

#### FRONT FORKS

Problem	Step 1	Step 2	Step 3
Bottoming	Increase air pressure	Use harder spring	—
Too soft	Increase air pressure	Increase oil viscosity (10 wt to 15 wt)	Use harder spring
Too hard	Decrease air pressure	Decrease oil viscosity (10 wt to 5 wt)	Use softer spring
GUIDELINES AND LIMITS			
(1)	Oil: STANDARD: 10 wt fork oil	ALTERNATE: 5 wt, 15 wt	
(2)	AIR PRESSURE:	MINIMUM: 0 kg/cm <sup>2</sup> (0 psi)	
		MAXIMUM: 1.2 kg/cm <sup>2</sup> (17.0 psi)	
		INCREASES: steps of 0.1 kg/cm <sup>2</sup> (1.5 psi)	

## REAR SHOCK ABSORBER

Problem	Step 1	Step 2	Step 3
Bottoming	Shorten the spring set length	Increase damping force	Use harder spring
Too soft	Increase damping force	Shorten the spring set length	Use hard spring
Too hard	Decrease damping force	Extend the spring set length	Use softer spring

### GUIDE LINES AND LIMITS

1. SET LENGTH                      MINIMUM: 345 mm (13.58 in)  
 MAXIMUM: 360 mm (14.17 in)  
 INCREASE: steps of 2 mm (0.08 in)

2. DAMPING FORCE                      Adjust by 1 or 2 clicks.  
 Do not jump over many clips at a time;  
 it may give the rider a misleading suspension feeling.

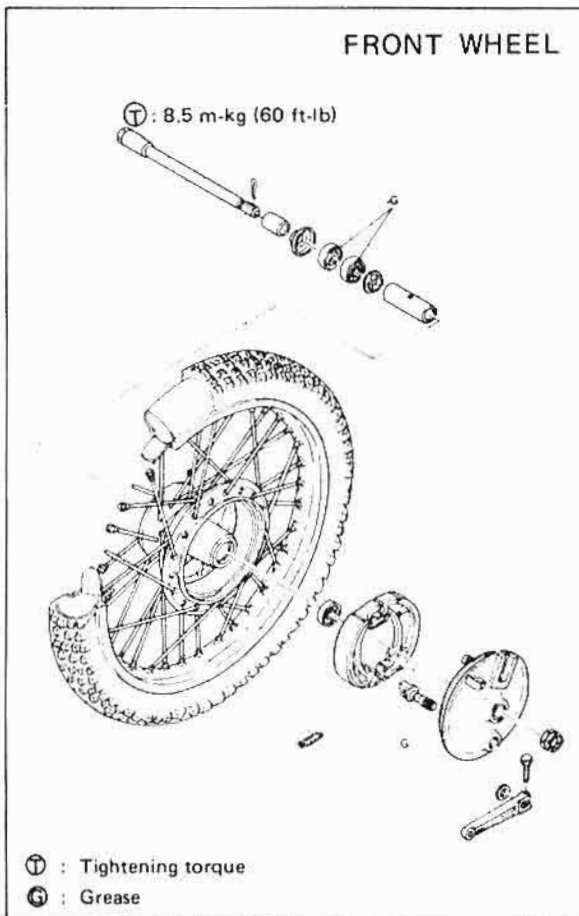

#### Front wheel removal

1. Elevate the front wheel by placing a suitable stand under the engine.
2. Remove brake cable: Loosen all cable adjuster screws and remove cable from handle lever holder. Then remove cable from cam lever at front brake shoe plate.

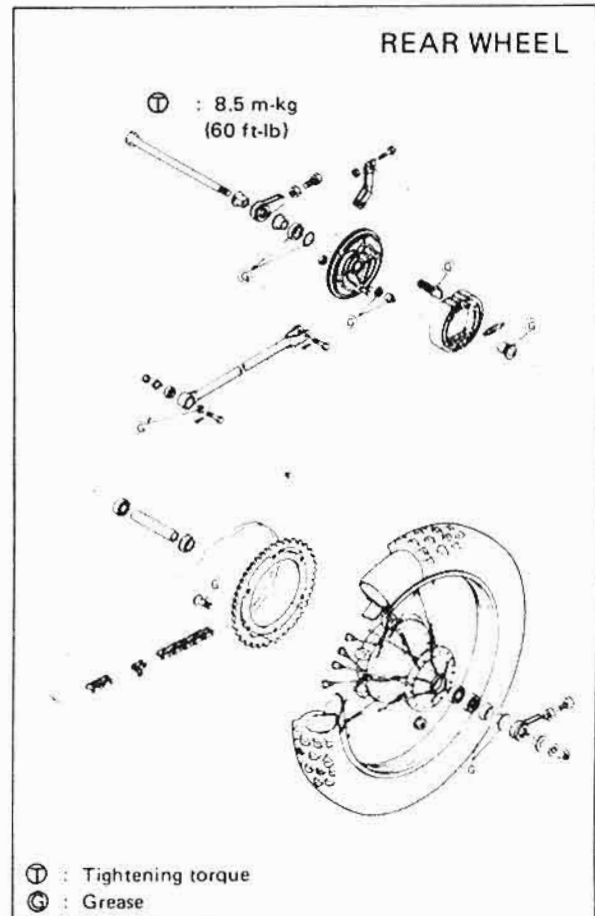

3. Loosen the front axle holder nuts.
4. Remove the cotter pin and axle nut.
5. Turn and pull out the front wheel axle, and remove the wheel assembly.

### Rear wheel removal

1. Elevate the rear wheel by placing a suitable stand under the engine.
2. Remove the tension bar and the brake rod from the brake shoe plate. The tension bar can be removed by removing the cotter pin and nut from the tension bar bolt. The brake rod can be removed by removing the adjuster.
3. Remove the master link clip and master link and remove the chain from the rear sprocket.
4. Remove the rear wheel axle nut.
5. Pull out the rear wheel axle.
6. Remove the rear wheel assembly.

### Check the rims and spokes

Place a suitable stand under the engine to raise wheels off the ground. Rotate a wheel by hand and check for rim run-out. If spokes are loose or bent, tighten or replace them. The spokes should be checked before each use.

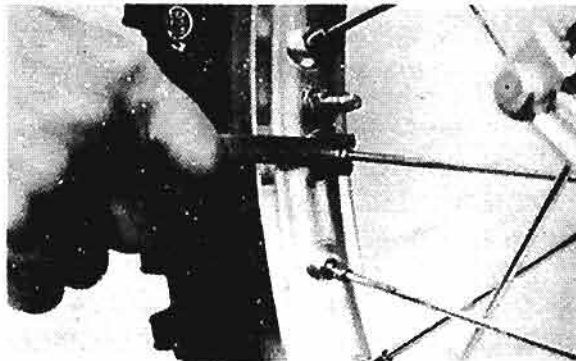

### Check the wheel bearings

Hold the top of the rear wheel with one hand and the frame with the other hand, and check the play of the wheel by shaking it sideways. If the bearings allow excessive play in the wheel or if it does not turn smoothly have your dealer replace the wheel bearings.

### Brake shoe inspection

Measure the outside diameter of the brake shoe set with slide calipers.

If they measure less than replacement limit, replace them. Smooth out any rough spots on shoe surface with sandpaper.

Brake shoe diameter	130 mm (5.12 in)
Replacement limit	126 mm (4.96 in)

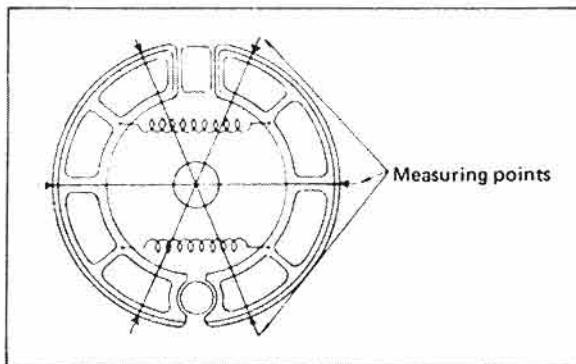

### Brake drum

Oil or scratches on the inner surface of the brake drum will impair braking performance or result in abnormal noises. Remove oil by wiping with a rag soaked in lacquer thinner or solvent. Remove scratches by lightly and evenly rubbing with emery cloth.

### Wheel installation

When installing wheels, reverse the removal procedure taking care of the following points.

1. Lightly smear grease on:
  - \* shafts
  - \* bearings and oil seal lips
  - \* O-ring and dust cover interior for the rear brake shoe plate
  - \* oil seal and collar outer circumference from the tension bar.
2. Check for proper engagement of the boss on the outer tube with the locating slot on the brake shoe plate.

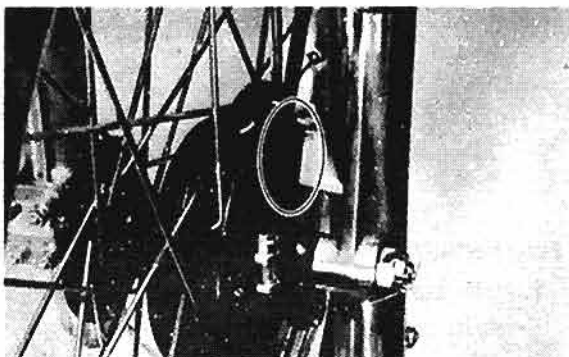

3. Always use a new cotter pins. Old pins should be discarded.
4. Make sure nuts are properly tightened.

Front wheel axle:	8.5 m-kG (60 ft-lb)
Axle holder nuts:	1.0 m-kG (7 ft-lb)
Rear wheel axle:	8.5 m-kG (60 ft-lb)
Tension bar:	2.3 m-kG (16 ft-lb)

**NOTE:**

When tighten the axle holder nuts, first tighten the nuts on the upper side of axle holder and tighten the nuts on the lower side.



5. Be sure to adjust the tension of the chain. (Refer to "Drive chain tension adjustment".)
6. During reassembly, the joint link clip must be installed with the rounded end facing the direction of travel.

**NOTE:**

The chain should be cleaned and lubricated after every use of the machine.

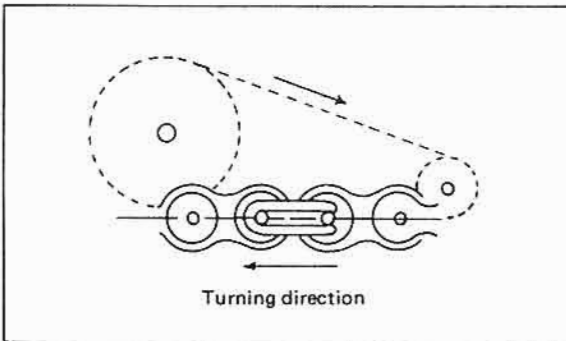

7. Adjust the plays in the brake lever and pedal.

**Sprockets**

**NOTE:**

Please refer to Maintenance and Lubrication Schedule Charts for additional information.

1. Check sprocket wear. Replace if wear decrease tooth height to a point approaching the roller center line.
2. Replace if tooth wear shows a pattern such as that in the illustration.

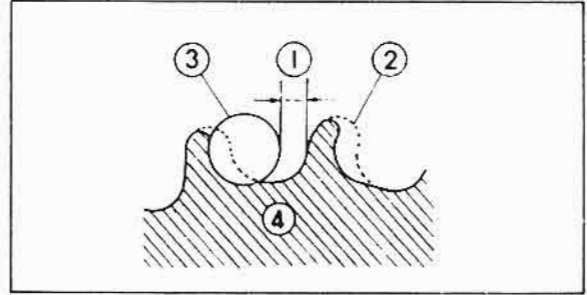

1. 1/4 tooth 2. Correct 3. Roller 4. Sprocket

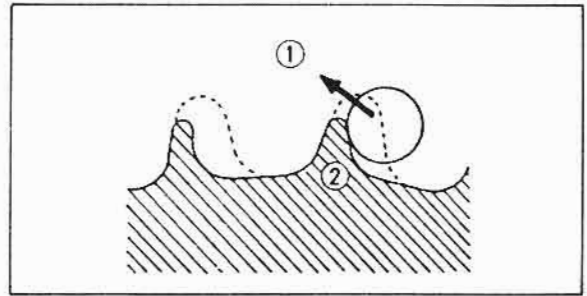

1. Slip off 2. Bend teeth

Drive sprocket securing nut torque:  
5.5 m-kG (40 ft-lb)

Driven sprocket securing nut torque:  
3.0 m-kG (22 ft-lb)

3. When replacing the drive sprockets, always use a new lock washer. After tightening the sprocket nut to the specification, be sure to lock it with the lock washer.

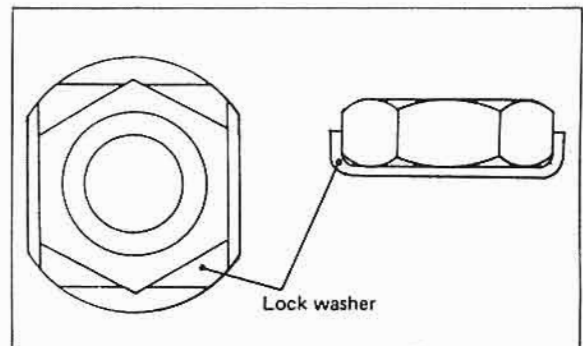

4. When installing the driven sprocket, lightly smear grease on the fitting bolts.

## Chain

### NOTE:

Please refer to Maintenance and Lubrication Schedule Charts for additional information.

1. Check the chain for stiffness. If stiff, soak in solvent solution, clean with medium bristle brush, dry with high pressure air. Oil chain thoroughly and attempt to work out kinks. If still stiff, replace.

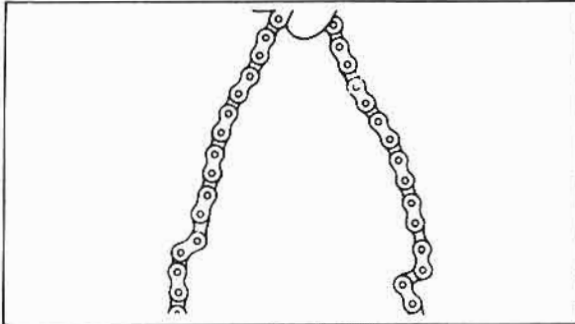

2. Check the side plates for visible wear. Check to see if excessive play exists in pins and rollers. Check for damaged rollers. Replace as required.
3. With the chain installed on the machine, excessive wear may be roughly determined by attempting to pull the chain away from the rear sprocket. If the chain will lift away more than one-half the length of the sprocket teeth, remove and inspect.

If any portion of the chain shows signs of damage, or if either sprocket shows signs of excessive wear, remove and inspect.

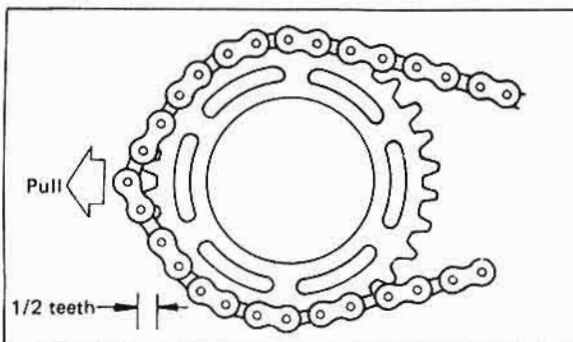

## STEERING HEAD

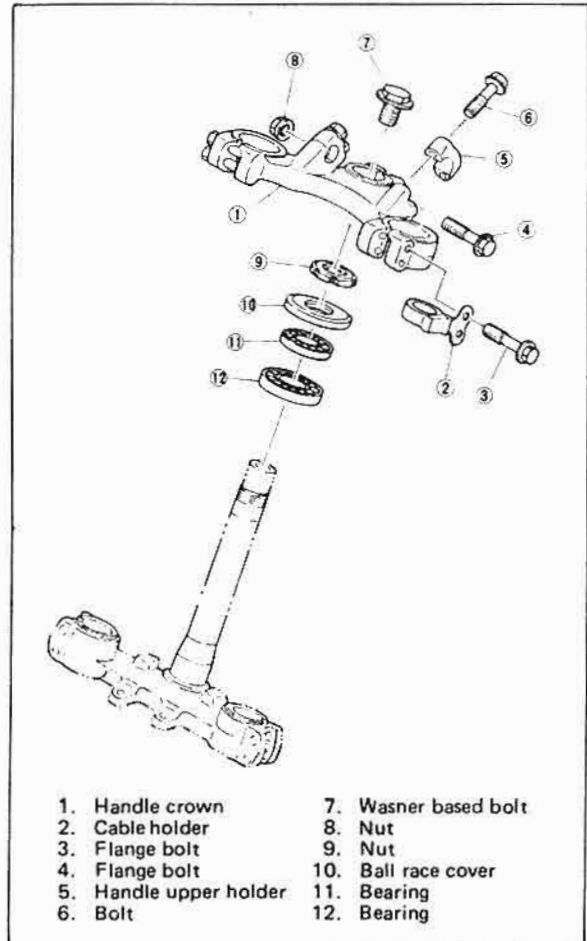

- |                        |                      |
|------------------------|----------------------|
| 1. Handle crown        | 7. Washer based bolt |
| 2. Cable holder        | 8. Nut               |
| 3. Flange bolt         | 9. Nut               |
| 4. Flange bolt         | 10. Ball race cover  |
| 5. Handle upper holder | 11. Bearing          |
| 6. Bolt                | 12. Bearing          |

### Inspection

1. Wash the bearings in solvent.
2. Inspect the bearings for pitting or other damage. Replace the bearings if pitted or damaged. Replace the races when bearings are replaced.
3. Clean and inspect the bearing races. If races are damaged, replace the races and bearings.
4. Install the bearings in the races. Spin the bearings by hand. If the bearings hang up or are not smooth in their operation in the races, replace bearings and races.

### Swing arm inspection

1. With shock absorber removed, grasp the ends of the arm and move from right to left to check for free play.

Swing arm free play:

0 ~ 1 mm (0 ~ 0.04 in)







2. The engine starts but will not pick up speed.

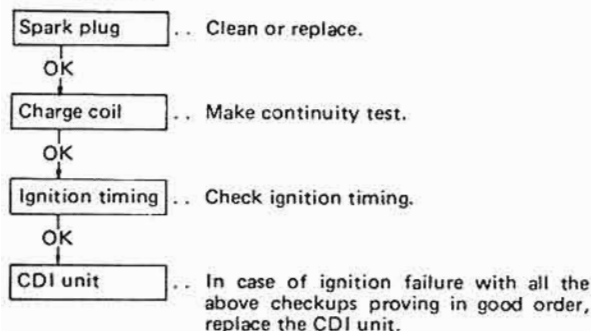

### Spark plug test

Remove the high tension wire from the spark plug cap, and hold it 5 mm off the plug. Kick the kick crank and check for spark.

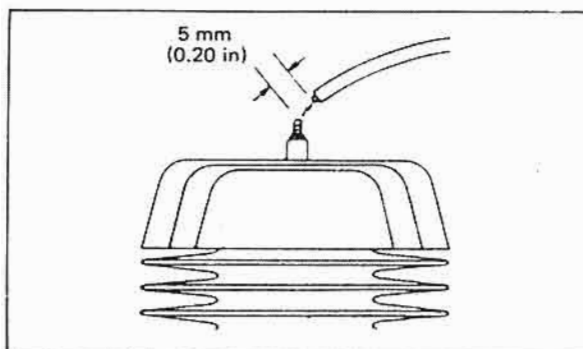

### Coil resistance test

Measure the resistance of the charge coil and pulser coil. If the resistance measured does not match the specification below, the coil is considered to be shorted or to have a broken wire.

Pulser coil and Charge coil:	470 $\Omega$ $\pm$ 10%
(High speed)	White/Red to Red
Charge coil:	1,470 $\Omega$ $\pm$ 10%
(Low speed)	Red to Brown

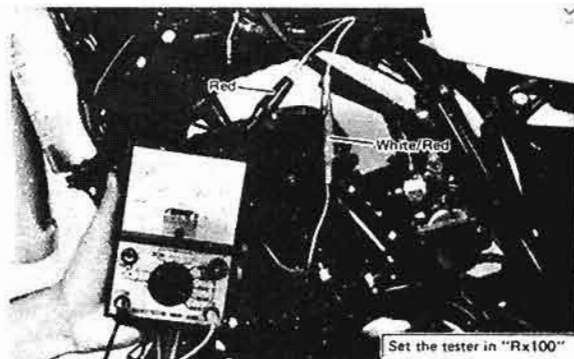
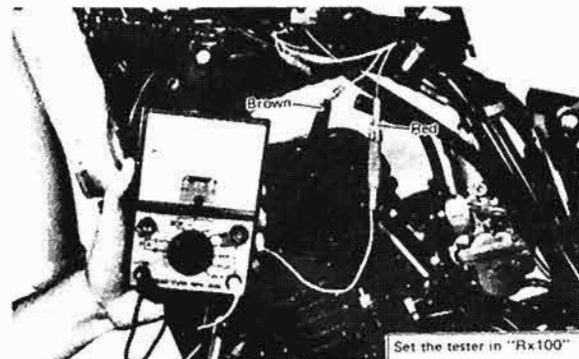

### Ignition coil test

Use a pocket tester or equivalent's ohmmeter to determine resistance and continuity of primary and secondary windings.

Primary coil resistance Use ( $\Omega$ x 1) scale	Secondary coil resistance Use ( $\Omega$ x 1K) scale
0.6 $\Omega$ $\pm$ 10%	6.2k $\Omega$ $\pm$ 10%



Primary winding resistance check

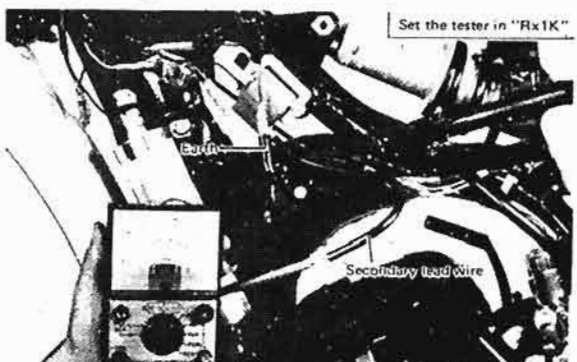

Secondary winding resistance check

### Engine stop switch

Switch may be checked for continuity with a pocket tester on the "RX1" position.

	Wire color	
	Black/White	Black
Push	○	○
Free	—	—



## MISCELLANEOUS

### WIRING DIAGRAM

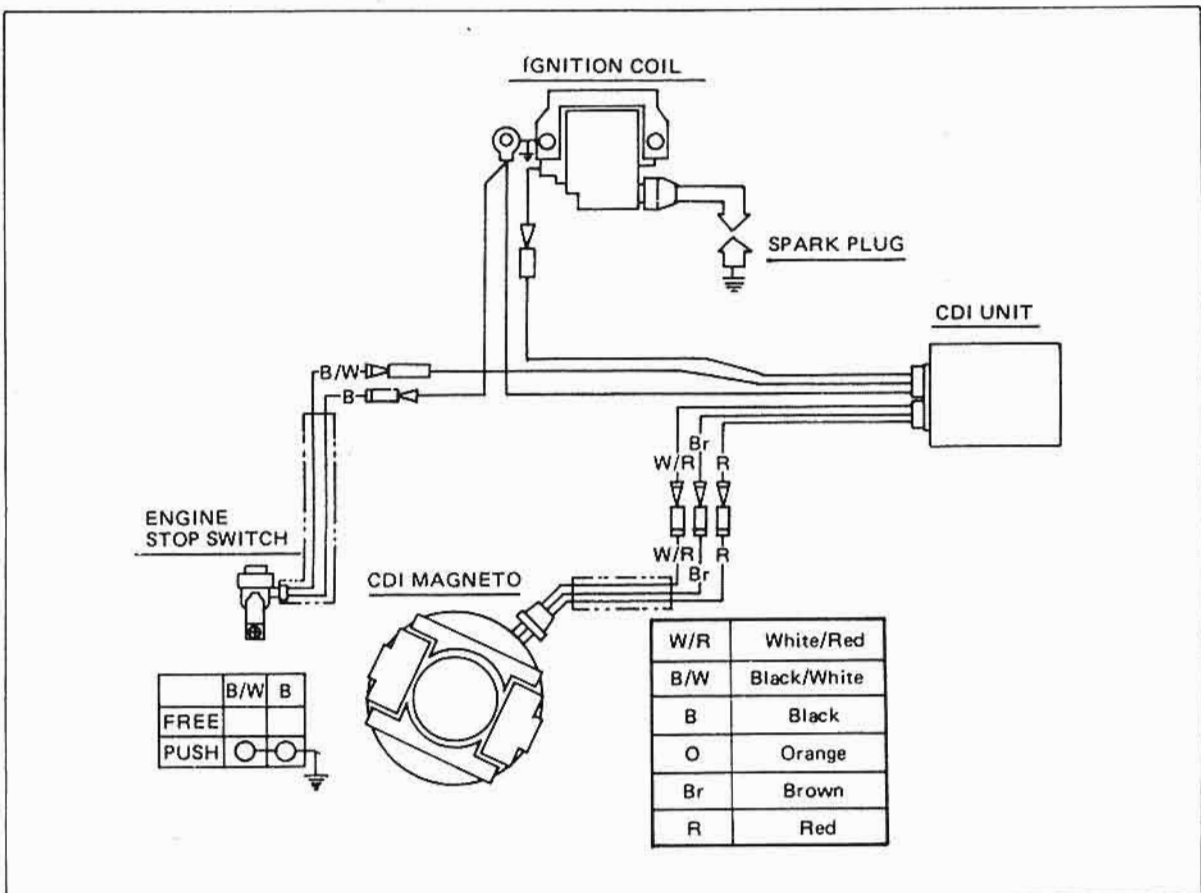

# CABLE ROUTING DIAGRAM

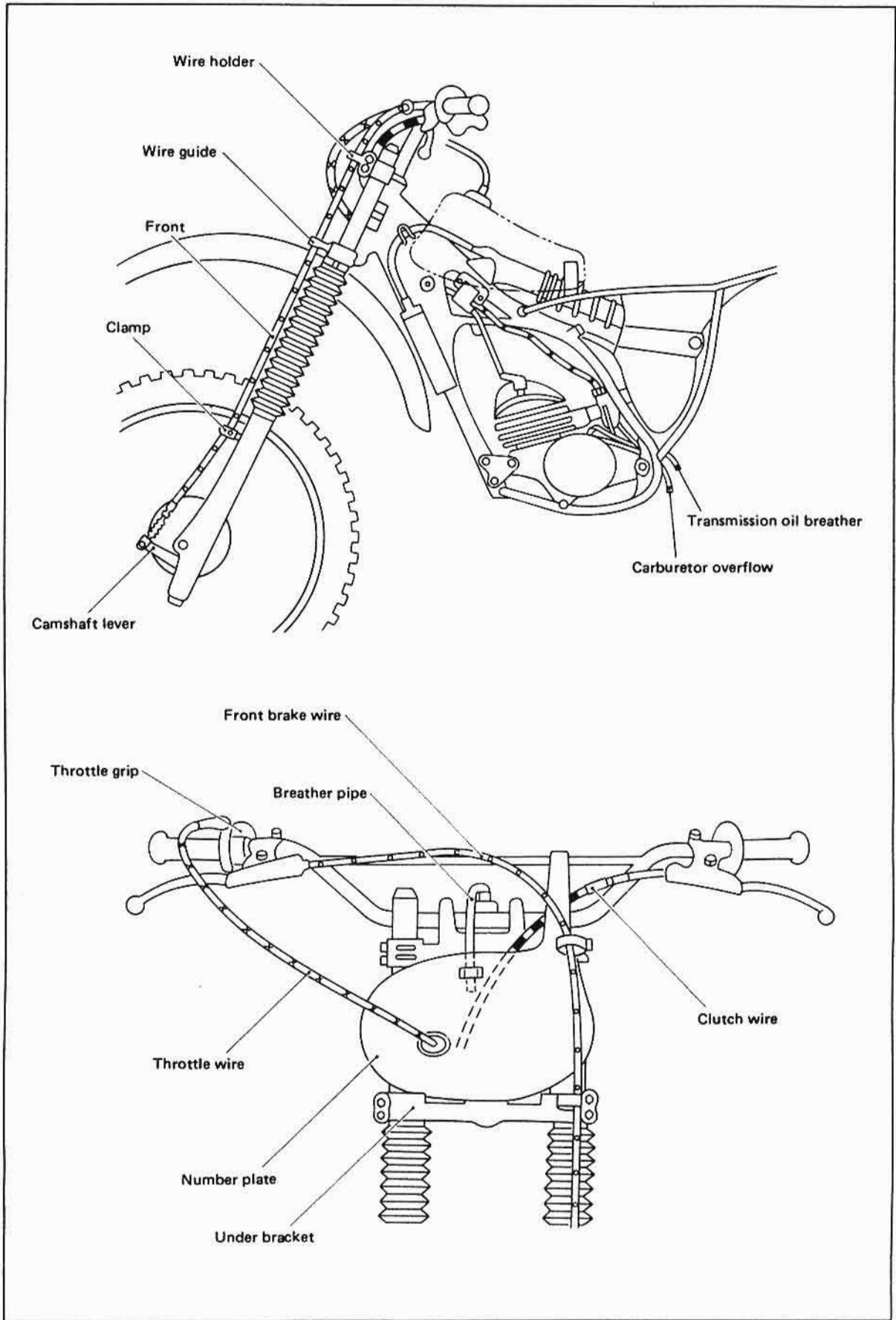

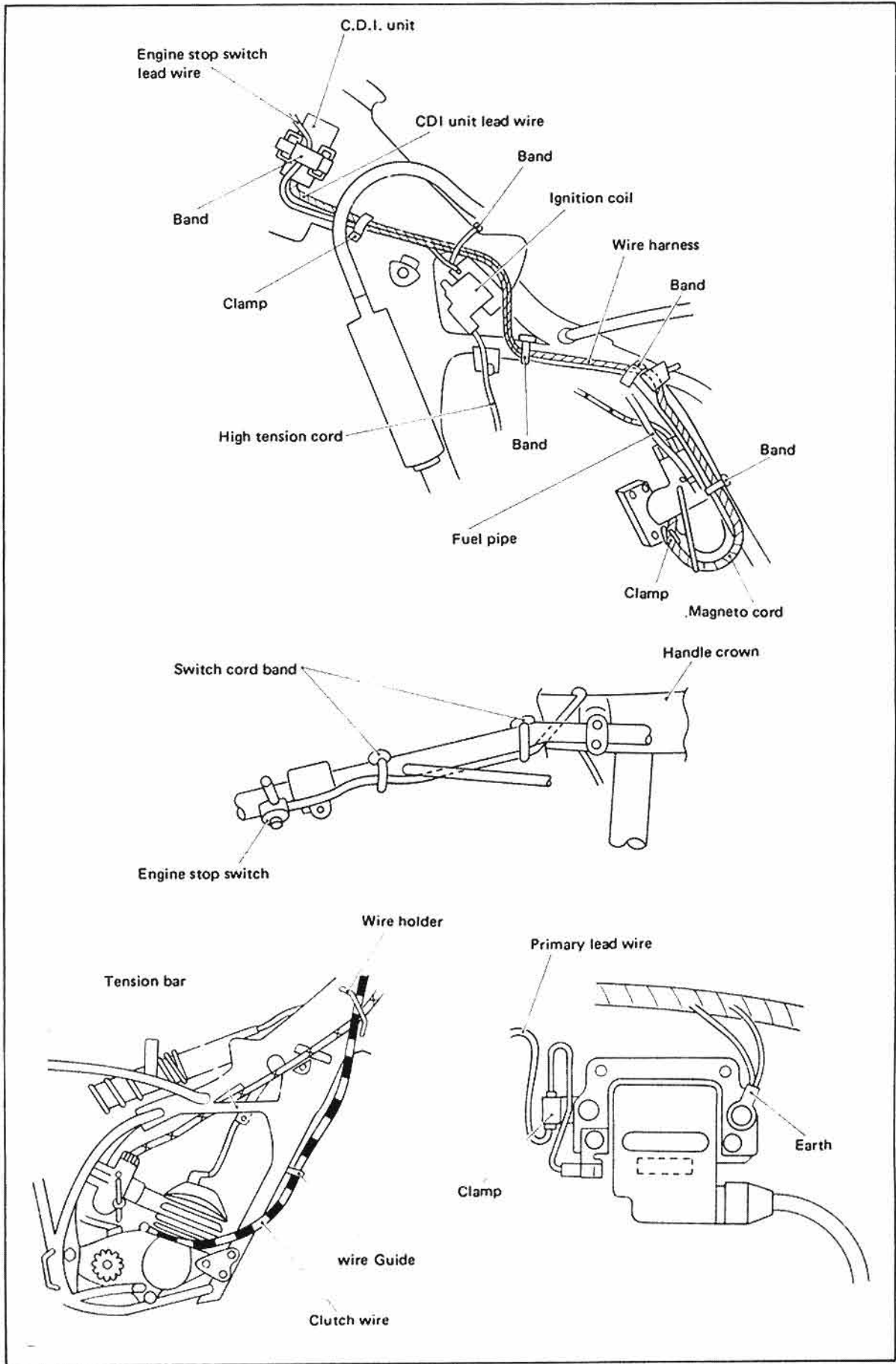

# TROUBLE SHOOTING GUIDE

Engine is hard to start or does not start.

Ignition System	
Possible Cause	Remedy
<ol style="list-style-type: none"> <li>1. Spark plug is wet.</li> <li>2. Ignition coil is faulty.</li> <li>3. C.D.I. unit is faulty.</li> <li>4. C.D.I. magneto is faulty (Pulser coil, source coil)</li> <li>5. Ignition timing is incorrect.</li> <li>6. Wire is broken, shorted or disconnected.</li> <li>7. Engine stop switch is shorted.</li> </ol>	<ul style="list-style-type: none"> <li>• Clean or replace</li> <li>• Replace</li> <li>• Replace</li> <li>• Replace</li> <li>• Adjust</li> <li>• Repair, replace or connect</li> <li>• Repair or replace</li> </ul>
Compression System	
Possible Cause	Remedy
<ol style="list-style-type: none"> <li>1. Piston rings are sticking or worn.</li> <li>2. Cylinder or piston is worn or scratched.</li> <li>3. Compression leaks past cylinder head gasket. (Head is distorted.)</li> <li>4. Crankshaft side oil seal is faulty.</li> <li>5. Air leaks past crankcase sealing surfaces.</li> </ol>	<ul style="list-style-type: none"> <li>• Replace</li> <li>• Repair or replace</li> <li>• Replace (or repair)</li> <li>• Replace</li> <li>• Repair</li> </ul>
Air/Fuel System	
Possible Cause	Remedy
<ol style="list-style-type: none"> <li>1. Carburetor pilot jet is clogged.</li> <li>2. Fuel petcock or pipe is clogged.</li> <li>3. Float valve is faulty. (Float height is too high or too low.)</li> <li>4. Reed valve is broken or deformed.</li> <li>5. Fuel tank filler cap or carburetor breather pipe is clogged.</li> <li>6. Air screw is improperly adjusted.</li> <li>7. Fuel is deteriorated.</li> <li>8. Oil-gas mixing ratio is incorrect.</li> <li>9. Air leaks through carburetor joints.</li> </ol>	<ul style="list-style-type: none"> <li>• Clean</li> <li>• Clean</li> <li>• Replace (remove gasoline from crankcase)</li> <li>• Replace</li> <li>• Clean</li> <li>• Adjust</li> <li>• Replace</li> <li>• Replace</li> <li>• Retighten or replace gasket.</li> </ul>

## Poor high speed performance

Ignition System	
Possible Cause	Remedy
<ol style="list-style-type: none"> <li>1. Spark plug is dirty or plug gap is too narrow.</li> <li>2. C.D.I. unit is faulty.</li> <li>3. C.D.I. magneto is faulty.</li> <li>4. Ignition coil is faulty.</li> <li>5. Ignition timing is incorrect.</li> <li>6. Loose wire connection.</li> </ol>	<ul style="list-style-type: none"> <li>• Clean, repair or replace</li> <li>• Replace</li> <li>• Replace</li> <li>• Replace</li> <li>• Adjust</li> <li>• Repair</li> </ul>
Compression System	
Possible Cause	Remedy
<ol style="list-style-type: none"> <li>1. Piston rings are sticking or worn.</li> <li>2. Cylinder or piston is worn or scratched.</li> <li>3. Compression leaks past crankcase sealing surfaces or crankshaft side oil seal.</li> <li>4. Carbon deposits in combustion chamber (Piston, Cylinder head).</li> </ol>	<ul style="list-style-type: none"> <li>• Replace</li> <li>• Repair or replace</li> <li>• Repair or replace</li> <li>• Decarbonize</li> </ul>
Air/ Fuel System	
Possible Cause	Remedy
<ol style="list-style-type: none"> <li>1. Clogged carburetor jets.</li> <li>2. Improperly adjusted main jet (High speed)</li> <li>3. Improperly adjusted jet needle (Medium speed)</li> <li>4. Incorrect fuel level</li> <li>5. Dirty or clogged air cleaner element</li> <li>6. Clogged fuel tank filler cap or carburetor breather pipe.</li> <li>7. Clogged fuel petcock or kinked fuel pipe.</li> <li>8. Deteriorated fuel.</li> <li>9. Improper oil-gas mixing ratio</li> <li>10. Cracked or broken exhaust pipe (Leakage of exhaust gases).</li> </ol>	<ul style="list-style-type: none"> <li>• Clean</li> <li>• Adjust</li> <li>• Adjust</li> <li>• Adjust</li> <li>• Clean</li> <li>• Clean</li> <li>• Clean or repair</li> <li>• Replace</li> <li>• Replace</li> <li>• Replace</li> </ul>



**Overheat**

Possible Cause	Remedy
<ol style="list-style-type: none"> <li>1. Incorrect air-fuel mixture</li> <li>2. Air leaks through carburetor joint.</li> <li>3. Incorrect ignition timing</li> <li>4. Carbon builds up in cylinder head or on piston head.</li> <li>5. Improper spark plug heat range (too hot)</li> <li>6. Fuel is deteriorated or oil-gas mixing ratio is incorrect.</li> </ol>	<ul style="list-style-type: none"> <li>• Adjust</li> <li>• Repair or replace</li> <li>• Adjust</li> <li>• Decarbonize</li> <li>• Replace</li> <li>• Replace</li> </ul>

**Transmission and shifter**

Trouble	Possible Cause	Remedy
Gears slip off	<ol style="list-style-type: none"> <li>1. Gear dogs are worn.</li> <li>2. Shift forks are bent.</li> <li>3. Shift cam stopper spring is fatigued.</li> </ol>	<ul style="list-style-type: none"> <li>• Replace</li> <li>• Replace</li> <li>• Replace</li> </ul>
Gear shifts skipping over the next.	<ol style="list-style-type: none"> <li>1. Shift cam stopper spring is fatigued.</li> <li>2. Shift forks are bent.</li> </ol>	<ul style="list-style-type: none"> <li>• Replace</li> <li>• Replace</li> </ul>
Gear does not shift correctly.	<ol style="list-style-type: none"> <li>1. Shift cam is worn. (broken)</li> <li>2. Change shaft is bent.</li> <li>3. Shift arm spring is broken.</li> <li>4. Gears are broken.</li> </ol>	<ul style="list-style-type: none"> <li>• Replace</li> <li>• Replace</li> <li>• Replace</li> <li>• Replace</li> </ul>
Shift pedal does not return.	<ol style="list-style-type: none"> <li>1. Change return spring is broken.</li> <li>2. Change shaft is bent.</li> </ol>	<ul style="list-style-type: none"> <li>• Replace</li> <li>• Replace</li> </ul>

**Clutch**

Trouble	Possible Cause	Remedy
Clutch slips	<ol style="list-style-type: none"> <li>1. Friction plate is worn.</li> <li>2. Clutch plate is worn.</li> <li>3. Clutch spring is fatigued.</li> <li>4. Pressure plate is deformed.</li> <li>5. Clutch play is too small.</li> <li>6. Clutch adjustment is incorrect.</li> <li>7. Match marks of clutch boss and pressure plate are not aligned.</li> </ol>	<ul style="list-style-type: none"> <li>• Replace</li> <li>• Replace</li> <li>• Replace</li> <li>• Replace</li> <li>• Adjust</li> <li>• Adjust</li> <li>• Reassemble</li> </ul>
Clutch drags	<ol style="list-style-type: none"> <li>1. Clutch plate is warped.</li> <li>2. Clutch lock nut is loosen.</li> <li>3. Friction plate is broken.</li> <li>4. Clutch play is too much.</li> <li>5. Oil viscosity is incorrect.</li> </ol>	<ul style="list-style-type: none"> <li>• Replace</li> <li>• Replace</li> <li>• Replace</li> <li>• Adjust</li> <li>• Replace</li> </ul>

## Chassis

Steering head is loose		
Possible Cause	Remedy	
<ol style="list-style-type: none"> <li>1. Roller is worn.</li> <li>2. Steering lock nut is loose.</li> </ol>	<ul style="list-style-type: none"> <li>• Replace</li> <li>• Retighten</li> </ul>	
Wheels have excessive run-out		
Possible Cause	Remedy	
<ol style="list-style-type: none"> <li>1. Bearing is worn.</li> <li>2. Rim has dent.</li> <li>3. Spokes are loose (or broken).</li> <li>4. Axle nut is loose.</li> </ol>	<ul style="list-style-type: none"> <li>• Replace</li> <li>• Repair or replace</li> <li>• Retighten or replace</li> <li>• Retighten</li> </ul>	
Brakes		
Problem	Possible Cause	Remedy
Faulty	<ol style="list-style-type: none"> <li>1. Brake shoes are worn.</li> <li>2. Brake is improperly adjusted.</li> <li>3. Brake drum contains water.</li> <li>4. Lining is greasy.</li> </ol>	<ul style="list-style-type: none"> <li>• Replace</li> <li>• Adjust</li> <li>• Clean</li> <li>• Degrease or replace</li> </ul>
Not return smoothly	<ol style="list-style-type: none"> <li>1. Wire is starved for oil.</li> <li>2. Camshaft is starved for grease.</li> <li>3. Return spring or brake shoe spring is broken.</li> <li>4. Brake pedal axle is starved for grease.</li> </ol>	<ul style="list-style-type: none"> <li>• Grease or replace</li> <li>• Grease</li> <li>• Replace</li> <li>• Grease</li> </ul>
Frame and Swing Arm		
Possible Cause	Remedy	
<ol style="list-style-type: none"> <li>1. Frame is cracked.</li> <li>2. Rear arm is bent.</li> <li>3. Rear arm is cracked.</li> <li>4. Bushing is worn.</li> </ol>	<p>Weld, reinforce or replace</p> <p>Repair or replace</p> <p>Replace</p> <p>Replace</p>	

## CLEANING AND STORAGE

### A. CLEANING

Frequent thorough cleaning of your machine will not only enhance its appearance but will improve general performance and extend the useful life of many components.

1. Before cleaning the machine:  
Block off end of exhaust pipe to prevent water entry; a plastic bag and strong rubber band may be used.
2. If engine case is excessively greasy, apply degreaser with a paint brush. Do not apply degreaser to chain, sprockets, or wheel axles.
3. Rinse dirt and degreaser off with garden hose, using only enough hose pressure to do the job. Excessive hose pressure may cause water seepage and contamination of wheel bearings, front forks, brake drums, and transmission seals. Many expensive repair bills have resulted from improper high pressure detergent applications such as those available in coin-operated car washers.
4. Once the majority of the dirt has been hosed off, wash all surfaces with warm water and mild, detergent-type soap. An old tooth brush can reach hard-to-get-to places.
5. Rinse machine off immediately with clean water and dry all surfaces with a chamois, clean towel, or soft absorbent cloth.
6. Immediately after washing, remove excess moisture from chain and lubricate to prevent rust.
7. Clean the seat with a vinyl upholstery cleaner to keep the cover pliable and glossy.
8. Automotive-type wax may be applied to all painted and chrome-plated surfaces. Avoid combination cleaner-waxes. Many contain abrasives which may mar paint or protective finish.
9. After finishing, start the engine immediately and allow to idle for several minutes.

### B. STORAGE

Long term storage (60 days or more) of your machine will require some preventive procedures to insure against deterioration. After cleaning machine thoroughly, prepare for storage as follows:

1. Drain fuel tank, fuel lines, and carburetor float bowl(s).
2. Remove spark plug, pour about one tablespoon of SAE 10W/30 oil in spark plug hole(s) and re-install spark plug. Kick engine over several times (with ignition off) to coat cylinder walls with oil.
3. Remove drive chain. Clean thoroughly with solvent and lubricate. Re-install chain or store in a plastic bag (tie to frame for safe-keeping).
4. Lubricate all control cables.
5. Block up frame to raise both wheels off ground.
6. Tie a plastic bag over exhaust pipe outlet to prevent moisture from entering.
7. If storing in humid or salt-air atmosphere, coat all exposed metal surfaces with a light film of oil. Do not apply oil to rubber parts or seat cover.

---

#### NOTE:

Make any necessary repairs before storing the machine.

---

# SPECIFICATIONS

## A. General

MODEL	YZ125G
<b>Model:</b> Model (I.B.M. No.) Frame I.D. and Starting Number Engine I.D. and Starting Number	3R3 3R3-000101 3R3-000101
<b>Dimension:</b> Overall length Overall width Overall height Seat height Wheelbase Minimum ground clearance	2,115 mm (83.37 in) 950 mm (37.4 in) 1,215 mm (47.8 in) 940 mm (37.0 in) 1,430 mm (56.3 in) 340 mm (13.4 in)
<b>Weight:</b> Net weight	85 kg (187 lb)

## B. Engine

MODEL	YZ125F
<b>Description:</b> Engine type  Engine model Displacement Bore x Stroke Compression ratio Starting system Ignition system Lubrication system	Air Cooled, 2-stroke, Gasoline Torque Induction system 3R3 123 cc (7.5 cu.in) 56 mm x 50 mm (2.2 in x 1.97 in) 8.4 : 1 Primary kick starter Capacitor Discharge Ignition Mixed Gas 32 : 1 (Yamalube "R") 20 : 1 (Shell Super M, Castrol R30)
<b>Cylinder head:</b> Cylinder head volume Combustion chamber type Head gasket material/thickness	8.2 cc (0.5 cu.in) Dome + Squish Copper/1.0 mm (0.04 in)
<b>Cylinder:</b> Material Bore size Wear limit Taper limit Out of round limit	Aluminum cylinder with cast iron sleeve 56 mm (2.205 in) 56.1 mm (2.208 in) 0.08 mm (0.003 in) 0.05 mm (0.002 in)
<b>Piston:</b> Piston skirt clearance Piston oversize	0.045 ~ 0.050 mm (0.0018 ~ 0.0020 in) 56.25, 56.50, 56.75, 57.00 mm (2.215, 2.224, 2.234, 2.244 in)





MODEL	YZ125G
Drive axle oil seal type (R) Secondary reduction method ratio	SD 26 x 38 x 5 Chain 48/12 (4.000)
Shifting mechanism: Type Oil seal type	Guide bar type S 12 x 21 x 4
Intake: Air cleaner, type Oil grade Reed valve, type Bending limit Valve lift	Oiled foam rubber Yamalube 2-cycle oil or Air cooled 2-cycle engine oil "V" type 1.4 mm (0.055 in) 7.0 ± 0.2 mm (0.28 ± 0.008 in)
Carburetor: Type and manufacturer I.D. mark Main jet (M.J.) Jet needle-clip position (J.N.) Needle jet (N.J.) Cutaway (C.A.) Pilot jet (P.J.) Air screw turns out (A.S.) Starter jet (G.S.) Float height	VM32SS/MIKUNI 3R300 # 300 6F22-3 P-8 3.0 60 1½ 80 23.4 ± 1.0 mm (0.92 ± 0.04 in)

### C. Chassis

MODEL	YZ125G
Frame: Design	Tubular steel semi double cradle
Steering: Caster Trail Head pipe bearing type	29° 125.5 mm (4.94 in) Taper roller bearing
Front suspension: Type Damper type Fork travel Front fork spring, free length spring rate Fork oil quantity type Oil seal type Air pressure	Telescopic fork Coil, air spring, and oil damper 300 mm (11.8 in) 563 mm (22.16 in) K = 0.217 kg/mm 360 cc (12.1 oz) SAE #10 motor oil SD-36-48-10.5 0 kg/cm <sup>2</sup> (0 psi)

MODEL	YZ125G
<b>Rear suspension:</b> Type Damper type Rear shock absorber spring: Free length Spring rate (Taper coil spring) Rear shock absorber travel Rear wheel travel Swing arm length deflection (rear end) free play (pivot shaft) Pivot shaft - bearing type	Monocross suspension (De Carbon system) Coil, gas spring + Oil damper  365 mm (14.4 in) K = 1.8 ~ 3.1 kg/mm 158 mm (6.22 in) 290 mm (11.4 in) 483 mm (19.0 in) 0 ~ 1.0 mm (0 ~ 0.039 in) 0 ~ 0.2 mm (0 ~ 0.0079 in) Needle bearing + TA2210Z /2
<b>Fuel tank:</b> Capacity	6.5 lit (1.72 US. gal)
<b>Wheels:</b> Tire size (F) (R) Manufacture Pattern Pressure (Normal) Front Rear Rim size (F) (R) Run out (vert.) Front – limit Rear – limit Run out (horiz.) Front – limit Rear – limit Bearing type and size Front wheel (L) (R) Rear wheel (L) (R) Oil seal type and size Front wheel (R) Rear wheel (L)	3.00-21-4PR 4.10-18-4PR Bridgestone Nobby  1.0 kg/cm <sup>2</sup> (14 psi) 1.0 kg/cm <sup>2</sup> (14 psi) 1.60-21 1.85-18  2 mm (0.08 in) 2 mm (0.08 in)  2 mm (0.08 in) 2 mm (0.08 in)  6202-RS 6202-3A 6202-3A 6302LU-3A  SD-20-35-7 SD-22-38-8
<b>Drive chain:</b> Type Number of links Chain pitch Free play	DK520DS 101L + joint 15.875 mm (0.625 in) 10 ~ 15 mm (0.394 ~ 0.591 in)
<b>Brakes (Front and Rear):</b> Type Brake drum I.D.:	Drum brake (Leading/trailing) 130 mm (5.12 in)

MODEL	YZ125G
Brake shoe dia. x width (F) (R)	130 mm x 22 mm (5.12 in x 0.87 in) 130 mm x 28 mm (5.12 in x 1.1 in)
Lining length	136.14 mm (5.36 in)
Lining thickness /wear limit	4 mm/2 mm (0.16 in/0.079 in)
Shoe springs free length	35 mm (1.38 in)

#### D. Electrical

MODEL	YZ125G
Ignition system: System Manufacture Model Charge coil resistance Low speed: High speed/ Pulser coil resistance:	Capacitor Discharge Ignition Hitachi M100-27  1.470 $\Omega$ $\pm$ 10% Red to Brown 470 $\Omega$ $\pm$ 10% Red to White/Red
Ignition timing (B.T.D.C.)	2.27 mm(0.089 in)
Ignition coil Manufacture Model Spark gap Primary winding resistance Secondary winding resistance	Hitachi CM61-20CY 6 mm (0.28 in) or more/300 r/min 0.6 $\Omega$ $\pm$ 10% 6.2k $\Omega$ $\pm$ 20%
Spark plug Manufacture and type Gap	Champion N-59G 0.7 mm (0.028 in)
C.D.I. unit Manufacture Model	Hitachi TIA01-24

A (NUT)	B (BOLT)	TORQUE SPECIFICATION	
		m-kg	ft-lb
10 mm	6 mm	0.6	4.5
12 mm	8 mm	1.5	11.0
14 mm	10 mm	3.0	22.0
17 mm	12 mm	5.5	40.0
19 mm	14 mm	8.5	61.0
22 mm	16 mm	13.0	94.0

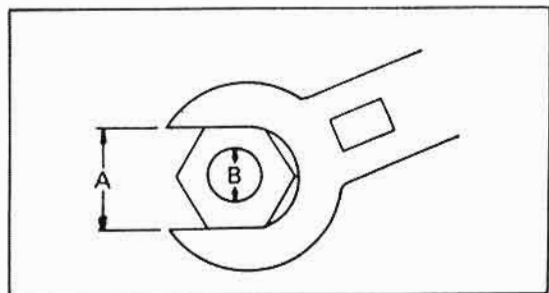

## E. TIGHTENING TORQUE

Engine	Tightening torque	
Cylinder head	M8	2.5 m·kg (18 ft·lb)
Spark plug	M14	2.5 m·kg (18 ft·lb)
Cylinder Nut	M8	3.0 m·kg (22 ft·lb)
Stud	M8	2.5 m·kg (18 ft·lb)
Primary drive gear	M12	6.0 m·kg (42 ft·lb)
Clutch boss (with lock washer)	M14	5.0 m·kg (36 ft·lb)
Clutch spring	M6	0.6 m·kg ( 4 ft·lb)
Drive sprocket (with lock washer)	M16	6.0 m·kg (42 ft·lb)
Kick crank	M10	3.5 m·kg (26 ft·lb)
Change pedal	M6	1.0 m·kg ( 8 ft·lb)
Reed valve	M3	0.1 m·kg (0.7 ft·lb) *
Inner rotor	M10	3.5 m·kg (26 ft·lb)
Stater	M6	0.8 m·kg ( 6 ft·lb)
<b>Chassis</b>		
Engine mounting bolt:		
Front	M8	3.0 m·kg (22 ft·lb)
Center	M8	3.0 m·kg (22 ft·lb)
Engine mount stay:	M8	3.0 m·kg (22 ft·lb)
Handle crown:		
Steering shaft	M14	9.5 m·kg (68 ft·lb)
Steering pinch	M8	2.3 m·kg (16 ft·lb)
Inner tube	M8	2.3 m·kg (16 ft·lb)
Handle holder	M8	2.3 m·kg (16 ft·lb)
Steering bearing	M25	1.0 m·kg ( 7 ft·lb)
Front fork:		
Cap bolt	M32	2.3 m·kg (16 ft·lb)
Under bracket	M8	2.3 m·kg (16 ft·lb)
Damper unit	M10	2.3 m·kg (16 ft·lb) *
Front wheel axle	M14	8.5 m·kg (60 ft·lb)
Front wheel axle holder	M8	1.0 m·kg ( 7 ft·lb)
Pivot shaft	M16	8.5 m·kg (60 ft·lb)
Rear wheel axle	M14	8.5 m·kg (60 ft·lb)
Sprocket wheel	M8	3.0 m·kg (22 ft·lb)
Rear suspension	M10	6.5 m·kg (46 ft·lb)
Tension bar	M8	2.3 m·kg (16 ft·lb)
Camshaft lever	M6	1.0 m·kg ( 7 ft·lb)
Footrest	M10	6.5 m·kg (46 ft·lb)
	M12	8.5 m·kg (60 ft·lb)

\* : Apply with a holding agent such as "LOCTITE"

## WARRANTY INFORMATION

Please refer to your copy of the Yamaha Owner's Warranty Guide\* for details of the warranty offered on your new Yamaha.

The Warranty Guide contains the warranty policy, an explanation of the warranty, and other important information. Becoming familiar with these policies will be to your advantage in making the best use of Yamaha's programs.

There are certain requirements which you must meet in order to qualify for warranty coverage. FIRST, your new Yamaha must be operated and maintained properly, as explained in this manual. If you have any questions about any procedure in this manual, please consult your dealer. ABUSE AND NEGLECTED MAINTENANCE MAY LEAD TO MECHANICAL FAILURES WHICH CANNOT BE COVERED UNDER WARRANTY.

SECOND, IF ANY PROBLEMS OCCUR WHICH YOU FEEL SHOULD BE COVERED UNDER WARRANTY NOTIFY YOUR DEALER IMMEDIATELY. Don't delay, as small problems left unrepaired can become large problems which may not be covered under warranty.

We recommend that the Warranty Guide be used as a folder in which you may keep your registration and other important documents related to your new Yamaha.

\* The Yamaha Owner's Warranty Guide is to be supplied by your Yamaha dealer at the time of purchase. If you did not receive one, or have lost yours, you may obtain extra copies upon request from your Yamaha dealer or by writing to:

YAMAHA MOTOR CORPORATION, U.S.A.  
P.O.Box 6555  
6555 Katella Ave.  
Cypress California 90630  
Attn: Warranty Department